



JCM
movelaria

Estante Sedução

Sedução Entertainment Center

Centro de Entretenimiento Sedução

















Indicamos que a montagem dos produtos seja realizada com parafusadeira eléctrica e por um montador profissional.
We recommend that a professional furniture assembler assemble the product by using a cordless screwdriver.
Se recomienda que un montador de muebles profesional realice el montaje del producto con un destornillador eléctrico.























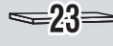

AVISO: Não nos comprometemos pelo mal-uso, montagem e fixação do produto à parede. Portanto, não somos responsáveis por danos e quedas do produto, eletrônicos e pertences neles contidos. É importante o uso de brocas e ferramentas compatíveis na montagem.
NOTICE: The company is not responsible for the misuse, assembly, and wall fixation, as well as the damages and falls that the products, electronics, and belongings therein might suffer. It is important to use suitable drills and tools to assemble the product.
ATENCIÓN: La empresa no se responsabiliza del mal uso, montaje y fijación del producto a la pared, así como de daños y caídas del producto, electrónicos u objetos. Es importante el uso de taladros y herramientas compatibles con el montaje.

Dica: para evitar possíveis avarias, use a embalagem do produto como apoio durante a montagem.
Tip: to avoid damages, use the product packaging as a base during the assembly.
Pista: para evitar daños, use el envase del producto como apoyo durante el montaje.

RELAÇÃO DE FERRAGENS | MOUNTING HARDWARE | HERRAMIENTAS DE MONTAJE

ADESIVO TAPA FURO 18mm	(A)	18mm ADHESIVE COVER CAP	(A)	TAPA ADHESIVA 18 mm	(A)		04
BUCHA MINIFIX	(B)	MINIFIX INSERT NUT	(B)	MANGUITO MINIFIX	(B)		04
CANTONEIRA 4 FURROS	(C)	4-HOLE ANGLE BRACKET	(C)	REFUERZO DE ÁNGULO 4 AGUJEROS	(C)		11
CAVILHA 6x30	(D)	6x30 DOWEL	(D)	CLAVIJA 6x30	(D)		04
KIT ROLDANA	(E)	ROLLER AND GUIDE FOR SLIDING DOOR	(E)	RODILLO Y GUÍA PARA PUERTA CORREDERA	(E)		01
PARAFUSO 3,5x14 CHATA	(F)	3.5x14 FLAT HEAD SCREW	(F)	TORNILLO DE CABEZA PLANA 3,5x14	(F)		70
PARAFUSO 4x25 CHATA	(G)	4x25 FLAT HEAD SCREW	(G)	TORNILLO DE CABEZA PLANA 4x25	(G)		18
PARAFUSO 3,5x30 FLANGEADO	(H)	3.5x30 FLANGE SCREW	(H)	TORNILLO DE FLANGE 3,5x30	(H)		08
PARAFUSO 5x40	(I)	5x40 SCREW	(I)	TORNILLO 5x40	(I)		32
PARAFUSO MINIFIX	(J)	MINIFIX BOLT	(J)	PERNO MINIFIX	(J)		14
PINO SUPORTE PRATELEIRA	(K)	SHELF SUPPORT	(K)	SOPORTE DE ESTANTE	(K)		04
PREGO 8x8	(L)	8x8 NAIL	(L)	CLAVO 8x8	(L)		30
TAMBOR MINIFIX 12x10	(M)	12x10mm MINIFIX CAM	(M)	CAJA DEL MINIFIX 12x10 mm	(M)		14
PÉ	(N)	FEET	(N)	PATAS	(N)		06

RELAÇÃO DE PEÇAS | **PARTS LIST** | LISTADO DE PARTES

	Rodapé Frontal Front Toe Zócalo Frontal	1Pc		Lateral Superior Direita Top Right Side Lateral Superior Derecho	1Pc
	Rodapé Traseiro Back Toe Zócalo Trasero	1Pc		Tampo Superior Top Tapa	1Pc
	Rodapé Interno Internal Toe Zócalo Interno	1Pc		Vista Superior Top Stretcher Travesaño Superior	1Pc
	Base Bottom Base	1Pc		Porta Traseira Wood Strip Panel Panel del Listones Madera	1Pc
	Tampo Inferior Midle Shelf Estante Central	1Pc		Porta Frontal Door Puerta	2Pcs
	Lateral Esquerda Bottom Left Side Lateral Izquierdo Inferior	1Pc		Painel Superior Vertical Open Shelf Unit Back Trasera de la Estanteria Abierta	1Pc
	Lateral Direita Bottom Right Side Lateral Derecho Inferior	1Pc		Painel Superior Horizontal Top Shelf Frame Moldura del Estante Superior	1Pc
	Divisão Inferior Esquerda Bottom Left Division División Inferior Izquierda	1Pc		Prateleira Superior Menor Small Top Shelves Estantes Superiores Pequeños	2Pcs
	Divisão Inferior Direita Bottom Stop Panel División Inferior Derecha	1Pc		Prateleira Inferior Bottom Shelf Estante Inferior	1Pc
	Lateral Tampo Meio Tv Shelf Left Side Lateral Izquierdo del Estante de TV	1Pc		Costas Inferior com Furos Back Panel With Hole Trasera con Agujero	1Pc
	Divisão Tampo Meio Middle Divider División Central	1Pc		Costas Inferior Back Panel Trasera Inferior	1Pc
	Tampo Meio Tv Shelf Estante de Tv	1Pc			
	Vista Tampo Meio Tv Shelf Frame Moldura del Estante de Tv	1Pc			
	Lateral Superior Esquerda Top Left Side Lateral Superior Izquierdo	1Pc			

- Passo 01 INICIE A MONTAGEM PELA PEÇA 12. ENCAIXE E APERTE AS PEÇAS 10, 11 E 7 NA PEÇA 12 COM MINIFIX (J+M). PARAFUSE A PEÇA 13 NA PEÇA 12 COM CANTONEIRA 4 FUROS (C+F).
- Step 01 START THE ASSEMBLY BY PART 12. FASTEN PARTS 10, 11, AND 7 TO PART 12 WITH MINIFIX (J+M). FASTEN PART 13 TO PART 12 WITH 4-HOLE ANGLE BRACKET (C+F).
- Paso 01 EMPIECE EL MONTAJE POR LA PARTE 12. FIJE LAS PARTES 10, 11 Y 7 A LA PARTE 12 CON MINIFIX (J+M). FIJE LA PARTE 13 A LA PARTE 12 CON REFUERZO ÁNGULO 4 AGUJEROS (C+F).

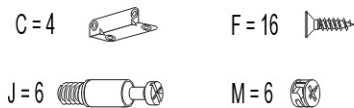
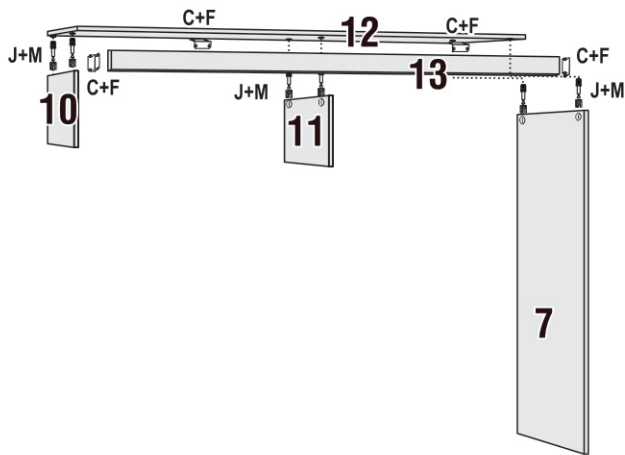

VISTA FRONTAL
FRONT VIEW
VISTA FRONTAL

- Passo 02 PARAFUSE A PEÇA 5 NAS PEÇAS 10, 11 E 7 COM PARAFUSO 5x40 (I). ENCAIXE E APERTE AS PEÇAS 6 E 9 NA PEÇA 5 COM MINIFIX (J+M). ENCAIXE A PEÇA 8 NA PEÇA 5 COM CAVILHA 6x30(D), PARAFUSE A PEÇA 4 NAS PEÇAS 6, 8, 9 E 7 COM PARAFUSO 5x40 (I).
- Step 02 FASTEN PART 5 TO PARTS 10, 11, AND 7 WITH 5x40 SCREWS (I). FASTEN PARTS 6 AND 9 TO PART 5 WITH MINIFIX (J+M). ATTACH PART 8 TO PART 5 WITH 6x30 DOWEL AND FASTEN PART 4 TO PARTS 6, 8, 9, AND 7 WITH 5x40 SCREWS (I).
- Paso 02 FIJE LA PARTE 5 A LAS PARTES 10, 11 Y 7 CON TORNILLOS 5x40 (I). FIJE LAS PARTES 6 Y 9 A LA PARTE 5 CON MINIFIX (J+M). ENCAJE LA PARTE 8 A LA PARTE 5 CON CAVIJA 6x30 Y FIJE LA PARTE 4 A LAS PARTES 6, 8, 9 Y 7 CON TORNILLOS 5x40 (I).

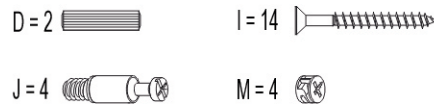
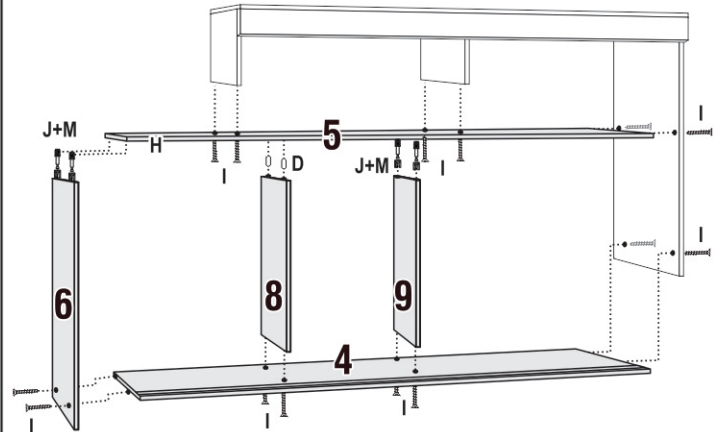

VISTA FRONTAL
FRONT VIEW
VISTA FRONTAL

- Passo 03 PARAFUSE A PEÇA 3 NA PEÇA 4 COM CANTONEIRA 4 FUROS (C+F). EM SEGUIDA, PARAFUSE AS PEÇAS 1 E 2 NAS PEÇAS 6, 7, 4 E 3 COM CANTONEIRA 4 FUROS (C+F) E OS PÉS (N) COM PARAFUSO 3,5x14 (F).
- Step 03 FASTEN PART 3 TO PART 4 WITH 4-HOLE ANGLE BRACKET (C+F). THEN FASTEN PARTS 1 AND 2 TO PARTS 6, 7, 4, AND 3 WITH 4-HOLE ANGLE BRACKET (C+F), AND FASTEN THE FEET (N) WITH 3.5x14 SCREWS (F).
- Paso 03 FIJE LA PARTE 3 A LA PARTE 4 CON REFUERZO DE ÁNGULO 4 AGUJEROS (C+F). DESPUÉS FIJE LAS PARTES 1 Y 2 A LAS PARTES 6, 7, 4 Y 3 CON REFUERZO DE ÁNGULO 4 AGUJEROS (C+F), Y FIJE LAS PATAS (N) CON TORNILLOS 3,5x14 (F).

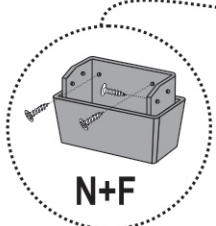
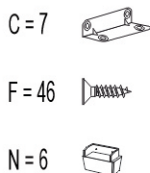
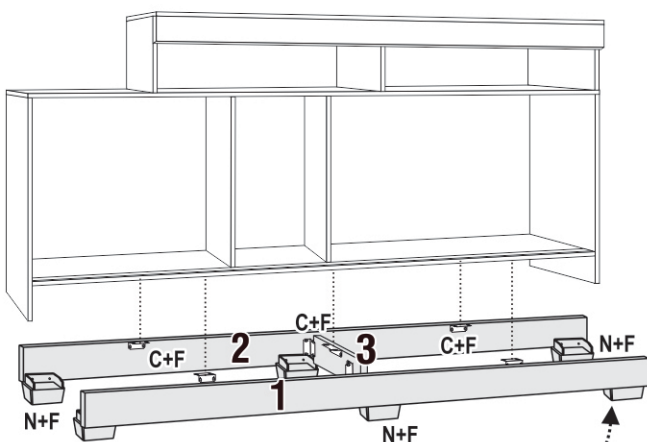

PARAFUSO 3,5x14(F)
NOS RODAPÉS E LATERAIS.
USE 3.5x14 SCREWS (F)
TO FASTEN THE TOE KICKS AND SIDES.
TORNILLO 3,5x14 (F) PARA FIJAR
LOS ZÓCALOS Y LOS LATERALES.

VISTA FRONTAL
FRONT VIEW
VISTA FRONTAL

- Passo 04 ENCAIXE E APERTE AS PEÇAS 14 E 15 NA PEÇA 12 COM MINIFIX (J+M+B). PARAFUSE A PEÇA 22 NA PEÇA 14 COM PARAFUSO 5x40 (I). PARAFUSE A PEÇA 20 NAS PEÇAS 5, 22 E 14 COM PARAFUSO 5x40 (I). ENCAIXE E PARAFUSE A PEÇA 17 NAS PEÇAS 14 E 15 COM CAVILHA 6x30 (D) E COM PARAFUSO 5x40 (I).
- Step 04 FASTEN PARTS 14 AND 15 TO PART 12 WITH MINIFIX (J+M+B). FASTEN PART 22 TO PART 14 WITH 5x40 SCREW (I). FASTEN PART 20 TO PARTS 5, 22, AND 14 WITH 5x40 SCREW (I). FASTEN PART 17 TO PARTS 14 AND 15 WITH 6x30 DOWEL (D) AND 5x40 SCREWS (I).
- Paso 04 FIJE LAS PARTES 14 Y 15 A LA PARTE 12 CON MINIFIX (J+M+B). FIJE LA PARTE 22 A LA PARTE 14 CON TORNILLOS 5x40 (I). FIJE LA PARTE 20 A LAS PARTES 5, 22 Y 14 CON TORNILLOS 5x40 (I). FIJE LA PARTE 17 A LAS PARTES 14 Y 15 CON CLAVIJA 6x30 (D) Y TORNILLOS 5x40 (I).

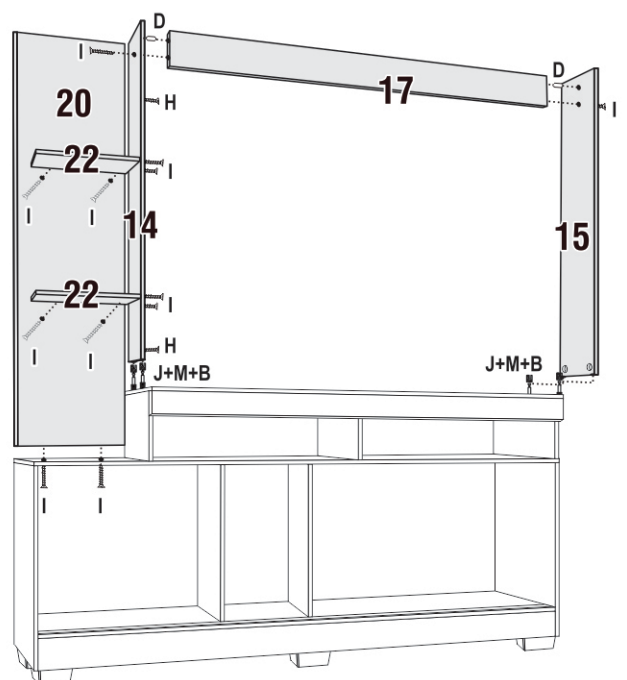



VISTA FRONTAL
FRONT VIEW
VISTA FRONTAL

Passo 05 PARAFUSE A PEÇA 16 NAS PEÇAS 14, 15 E 20 COM PARAFUSO 5x40 (I) E PARAFUSE O TUBO COM PARAFUSO 3,5x30 FLANGEADO(H), PARAFUSE A PEÇA 21 NA PEÇA 16 COM PARAFUSO 3,5x30 FLANGEADO (H).

Step 05 FASTEN PART 16 TO PARTS 14, 15, AND 20 WITH 5x40 SCREWS (I), AND FASTEN THE TUBE WITH 3.5x30 FLANGE SCREWS (H), FASTEN PART 21 TO PART 16 WITH 3.5x30 FLANGE SCREWS (H).

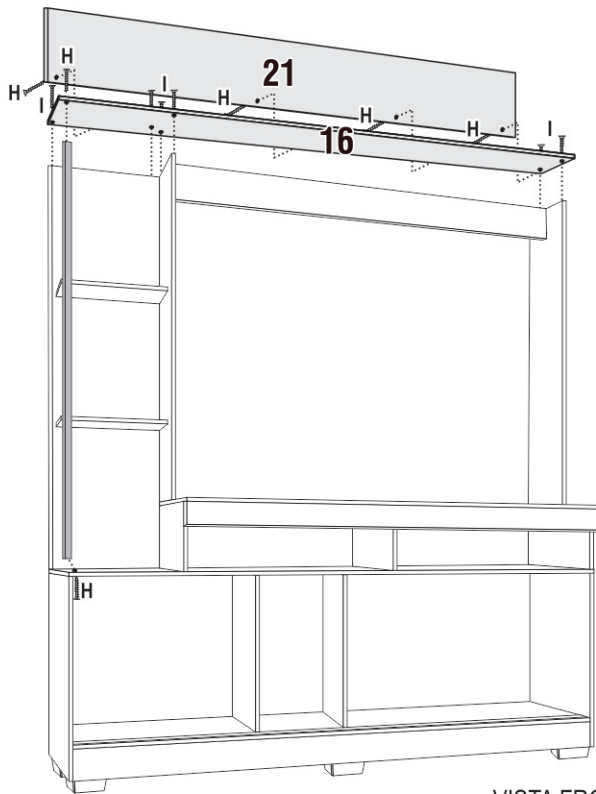
Paso 05 FIJE LA PARTE 16 A LAS PARTES 14, 15 Y 20 CON TORNILLOS 5x40 (I) Y FIJE EL TUBO CON TORNILLOS FLANGE 3,5x30 (H), FIJE LA PARTE 21 A LA PARTE 16 CON TORNILLOS FLANGE 3,5x30 (H).



H=6  I=6 

VISTA FRONTAL
FRONT VIEW
VISTA FRONTAL

Passo 06 PREGUE AS COSTAS COM PREGO 8x8 C/C (L).

Step 06 FASTEN THE BACK WITH 8x8 NAILS (L).

Paso 06 FIJE LA TRASERA CON CLAVOS 8x8 (L).

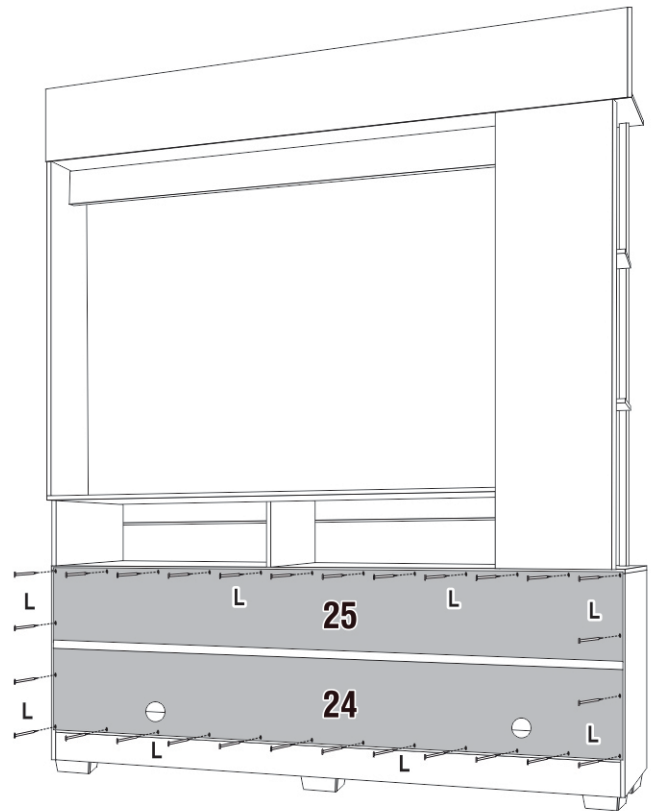

L=30 

VISTA TRASEIRA
BACK VIEW
VISTA TRASERA

Passo 07 MONTE A PORTA COM AS RESPECTIVAS FERRAGENS, CONFORME DESENHO ABAIXO.

Step 07 ASSEMBLE THE DOORS WITH ITS HARDWARE, ACCORDING TO THE PICTURE BELOW.

Paso 07 MONTE LA PUERTA CON SUS HERRAJES, SEGÚN EL DISEÑO ABAJO.

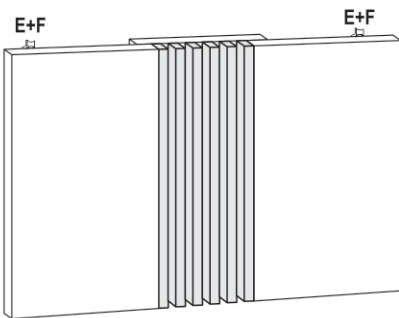

VISTA FRONTAL
FRONT VIEW
VISTA FRONTAL

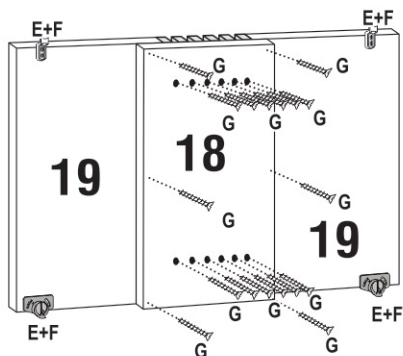

E=1 

F=8 

G=18 

VISTA TRASEIRA
BACK VIEW
VISTA TRASERA

Passo 08 ENCAIXE A PORTA E MONTE A PRATELEIRA Nº 23 COM PINO SUPORTE PRATELEIRA (K).

Step 08 ATTACH THE DOOR. INSERT THE SHELF (23) WITH ITS SUPPORTS.

Paso 08 ENCAJE LA PUERTA. PONGA EL ESTANTE (23) CON SUS SOPORTES.

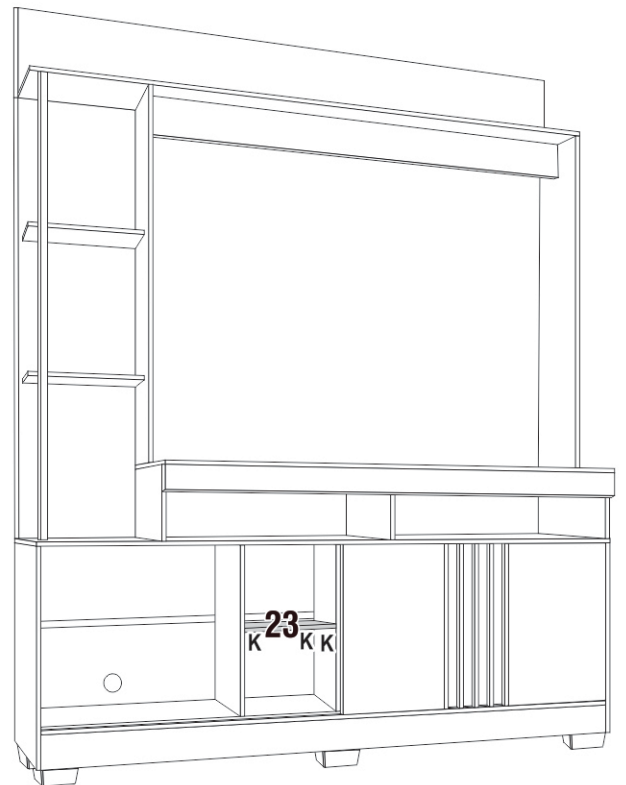

K=4 

VISTA FRONTAL
FRONT VIEW
VISTA FRONTAL