

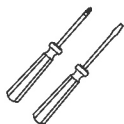

**ROUPEIRO NEW MASTER 04 PTS**  
**Cód.: 8712**

**Benetil**  
Móveis

Av. Jesus Candian, 395 - B. Mangueira Rural  
**Telefax (32) 3539-5350**  
CEP 36500-000 - Ubá - Minas Gerais  
[www.benetil.com.br](http://www.benetil.com.br)



## DETALHES IMPORTANTES

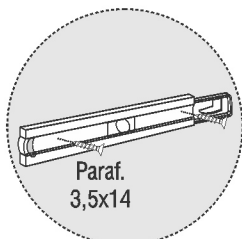

Paraf.  
3,5x14

Corrediça Telecópica

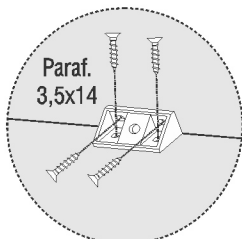

Paraf.  
3,5x14

Cantoneira 4 Furos



32 3539.5350  
[www.benetil.com.br](http://www.benetil.com.br)

## COMPONENTES

NUM.	PEÇA	QUANT.
01	LATERAL ESQUERDA	01
02	RODAPÉ MAIOR	02
03	RODAPÉ MENOR	01
04	LATERAL DIREITA	01
05	PÉ	06
06	BASE	01
07	DIVISÕES	01
08	PRATELEIRA GAVETEIRO	01
09	PRATELEIRA CENTRAL INFERIOR	01
10	PRATELEIRA CENTRAL SUPERIOR	01
11	DIVISÃO DO NINCHO	01
12	PRAT. NINCHO	02
13	TAMPO INTERMEDIÁRIO	01
14	DIVISÃO DO MALEIRO	01
15	TAMPO SUPERIOR	01
16	VISTA SUPERIOR	01
18	FRENTE GAVETA	03
19	LATERAIS GAVETA	06
20	TRASEIRO GAVETA	03
21	FUNDOS DE GAVETA	03
22	COSTAS	02
23	PORTAS	04

**ATENÇÃO: EM CASO DE ASSISTÊNCIA, VERIFICAR O NÚMERO DO LOTE DE PRODUÇÃO, NO TOPO DAS PEÇAS E NA ETIQUETA DA CAIXA DO PRODUTO.**

**RESERVAMO-NOS O DIREITO DE EFETUAR MODIFICAÇÕES TÉCNICAS OU DE MATERIAIS SEM PRÉVIO AVISO.**

# RELAÇÃO DE FERRAGENS EM TAMANHO REAL (MEDIDA EM MILÍMETRO).



A - PARAF. 3,5x14



B - PARAF. 5x40 SEM PONTA

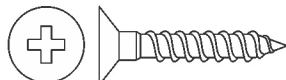

C - PARAF. 4,0x25

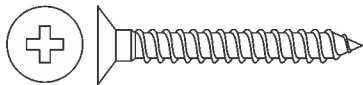

D - PARAF. 4,0x35

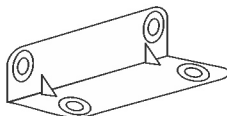

E - CANTONEIRA 4 FUROS



F - SACHÊ DE COLCA

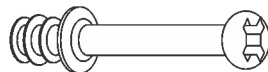

G - MINIFIX SIMPLES

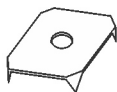

H - FIXADOR DE COSTAS



I - TAMBOR MINIFIX



J - TAMPA ADESIVA



K - PARAF. 3,5x14 FLANGEADO

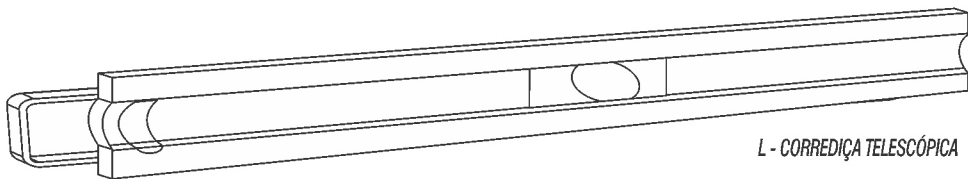

L - CORREDIÇA TELESCÓPICA



M - PUXADOR

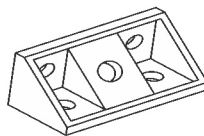

N - CANTONEIRA 4 FUROS

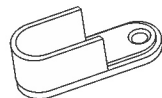

O - SUPORTE CABIDEIRO



P - CABIDEIRO



Q - CAVILHA 6x30



R - PREGO 10x10

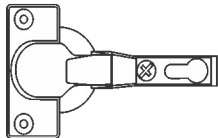

T - DOBRADIÇA

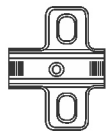

U - CALÇO

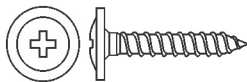

V - PARAF. 3,5x20 FLANGEADO

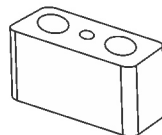

W - ALONGADOR DE CORREDIÇA



UTILIZE A RÉGUA PARA A MEDIÇÃO DOS PARAFUSOS

# FAVOR IDENTIFICAR AS PEÇAS E COLOCAR SEUS RESPECTIVOS ACESSÓRIOS

## Sequência de Montagem

- 01 - Parafusar peças 1 na peça 2.
- 02 - Parafusar peças 3 nos rodapés 2
- Observação: Seguir a furação que vai em cima do rodapé 2 para colocação do rodapé 03 tem que ficar alinhado.
- 03 - Parafusar peça 4 nas peças 2;
- 04 - Parafusar os Pés 5 nos rodapés 2.

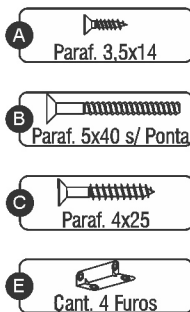

## Sequência de Montagem

- 05- Encaixar e Parafuse peça 6 nos rodapés 2 e laterais 1 e 4;
- 06- Encaixar e parafusar peças 7 na peça 6;
- 07- Parafusar peças 8 nas peças 7 e 4;
- 08 - Encaixar peça 9 nas peças 1 e 7.

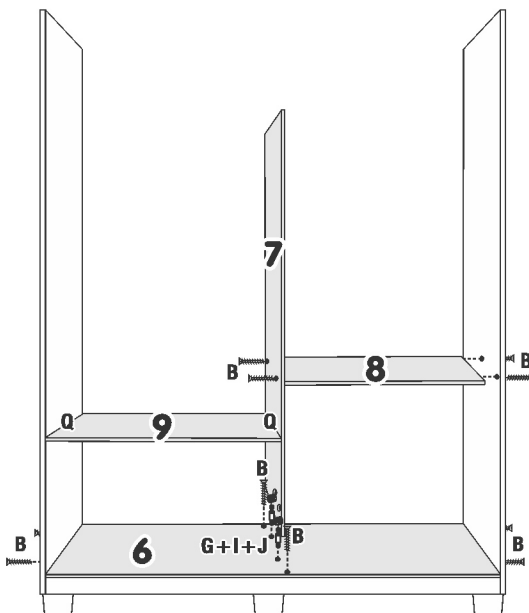
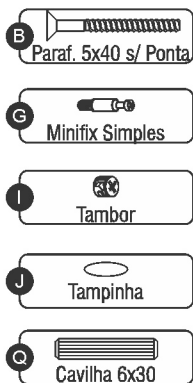

## Sequência de Montagem

- 09 - Parafusar a peça 10 nas peças 1 e 7;
- 10 - Parafusar a peça 13 nas peças 1 e 4 em seguida parafusá-la na peça 7;
- 11 - Parafusar peça 11 nas peças 10 e 13;
- 12 - Fixar as Peças 12 nas peças 1, 7 e 11.

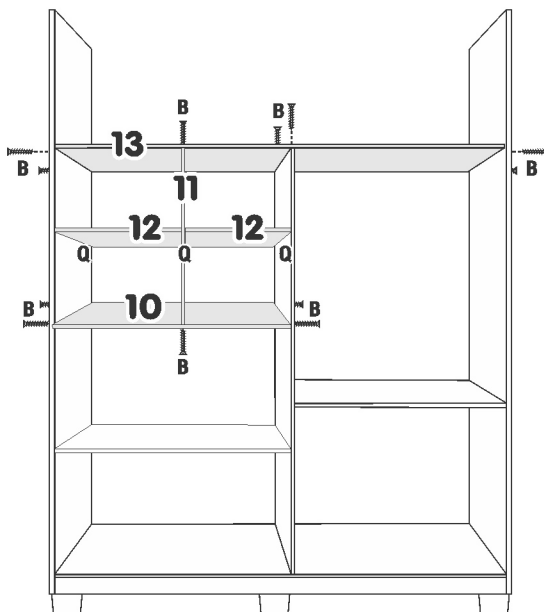
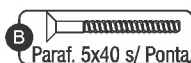
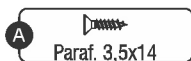

## Sequência de Montagem

- 13 - Fixar e parafusar peças 14 na peça 13.
- 14 - Encaixar e parafusar peça 15 na peças 01 e 04 e depois parafusá-la nas peças 14.

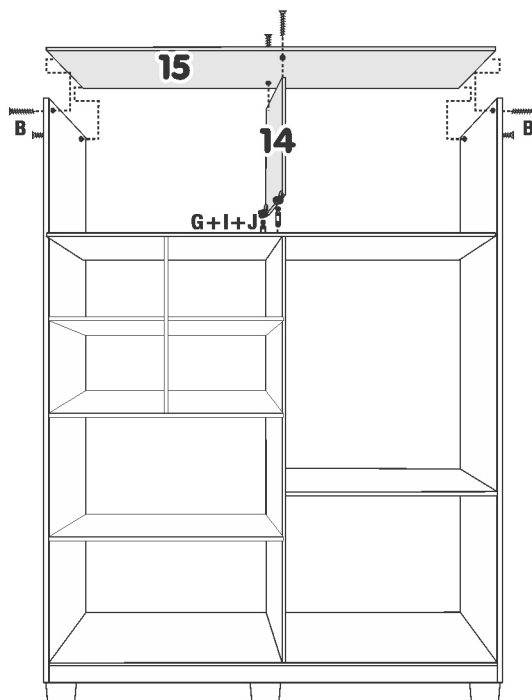
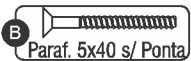

### Seqüência de Montagem

- 15 - Fixar peças 16 nas peças 01, 04 e também na peça 15.
- 16 - Parafusar Alongador de correção conforme desenho.

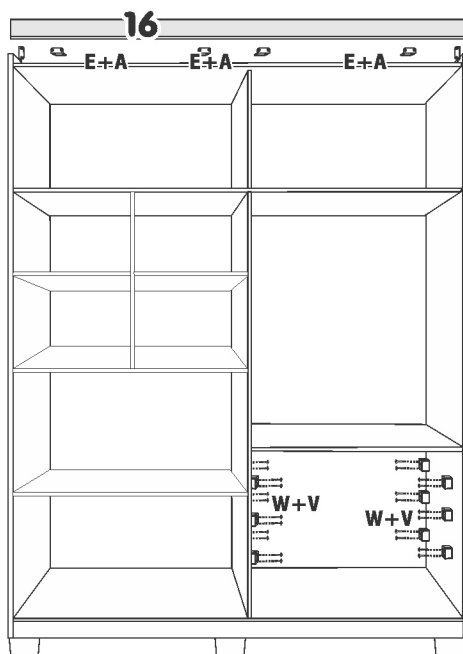

### Seqüência de Montagem

- 17 - Montar os cabideiros com os suportes.
- 18 - Parafusar as correções.

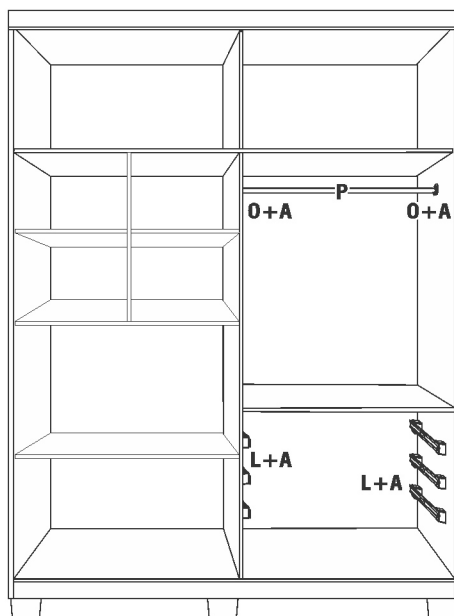

## Sequência de Montagem

19 - Pregiar as Costas 22 com perfil H  
23.

OBS.: Acertar as costas para melhor  
esquadramento do móvel.

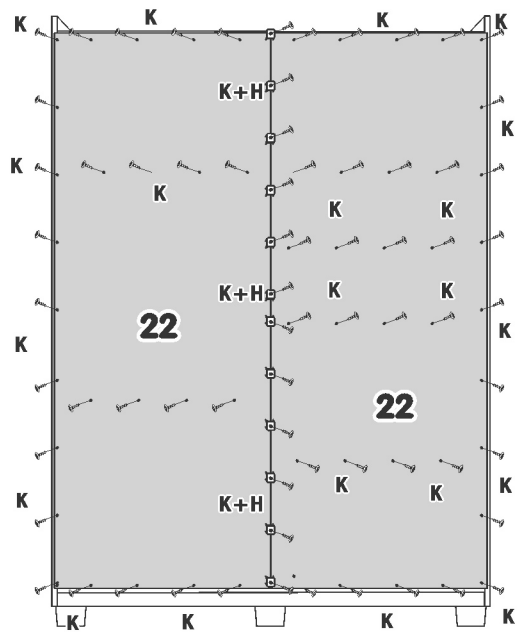
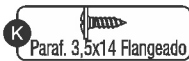

## Sequência de Montagem

20 - Montar e fixar as Portas 23.

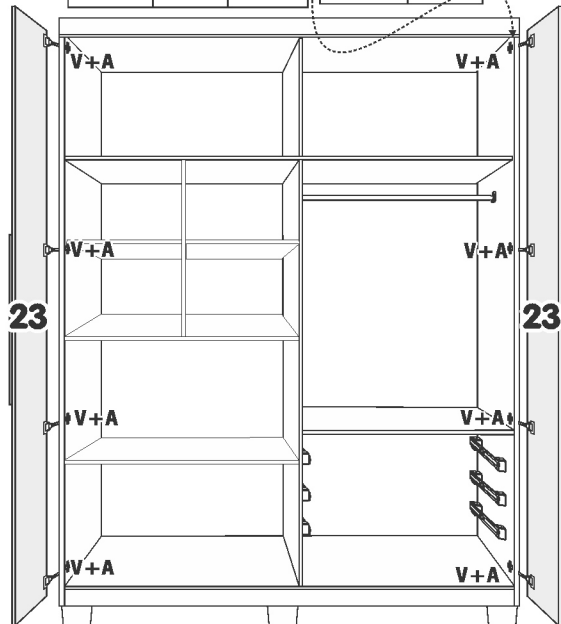
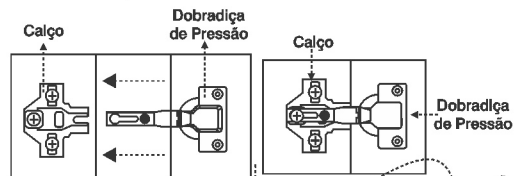
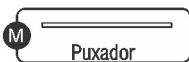
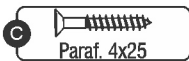
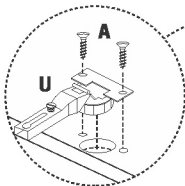

## Sequência de Montagem

- 20 - Parafusar as cantoneiras nas peças 19;
- 21 - Parafusar as peças 19 na peça 18 colocando cola nas cavilhas;
- 22 - Parafusar a peça 20 nas peças 19;
- 23 - Parafusar peça 21 nas peças 19 e 20 conforme desenho abaixo, ajustando para melhor esquadrejamento da gaveta;
- 24 - Parafusar as corredeiras na lateral da peça 19;

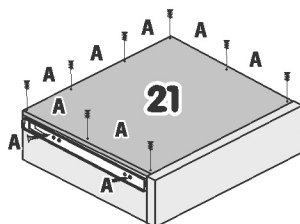
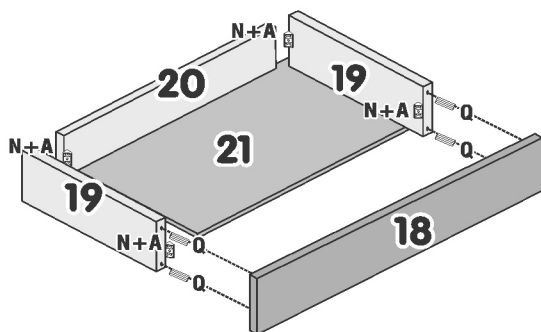
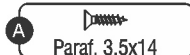

# Benetil

Móveis

Av. Jesus Candian, 395 - B. Mangueira Rural

Telefax (32) 3539-5350

CEP 36500-000 - Ubá - Minas Gerais

[www.benetil.com.br](http://www.benetil.com.br)