



MAVAULAR móveis

Fone (32) 3539-7600

Rod. Ubá - Rodeiro, Km 03 - Galpão 1

C. P. 050 - CEP 36500-000 - Ubá - MG

E-mail: mavaular@mavaular.com.br - Site: www.mavaular.com.br

f @ Mavaular Móveis

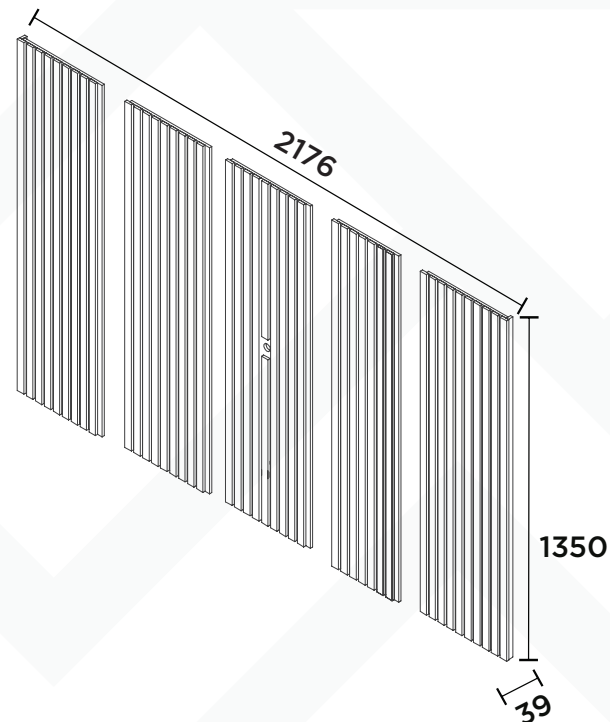

Instruções de Montagem Painel Versatilis 2200

Assembly Instructions Panel Versatilis

Instrucciones de montaje Panel Versatilis

CÓDIGO: 12886

Atualizado em:
30/01/2024

CUIDE BEM DO SEU MÓVEL

Dicas de limpeza e conservação:

- Para limpar corretamente seu produto, use sempre um pano liso e **levemente** umedecido com água;
- Não se esqueça de enxugar o seu móvel! Ele não deve permanecer úmido, pois a água pode prejudicar o acabamento ou causar mofo na madeira;
- Não se recomenda o uso de produtos à base de amoníaco.
- Não utilize esponja de aço ou qualquer material que possa arranhar a superfície do produto durante a limpeza.
- Não utilize plásticos ou papéis coloridos para forrar seu móvel.
- Evite arrastar objetos em cima do móvel. Eles podem riscar e prejudicar o acabamento de seu móvel de
- O material dos seus móveis tem um tratamento contra fungos e cupins, mesmo assim, em ambientes infestados recomenda-se a dedetização antes de instalar a seu móvel;
- Tente evitar a exposição direta ao sol. Sugere-se utilização de cortinas para proteger seu móvel;

TAKING GOOD CARE OF YOUR FURNITURE

Cleaning and caring instructions:

- Wipe the wood furniture down with a moist cloth to properly clean the furniture.
- Do not forget to dry your furniture out. Humidity can damage the finish or create mould.
- Chemical products are not recommended;
- Never clean the furniture with scouring powders, steel scrubber pads or any other product which can scratch its surface.
- Furniture surfaces should not be covered with colored plastic or paper sheets.
- Avoid dragging objects on top of the furniture. They might scratch the finishing.
- Wood furniture are made of mould and termites resistant materials, however, it is recommended to use termiticides in infested places before installing the furniture.
- Avoid furniture exposure to direct Sun light. Drapers suggested.

CUIDE BIEN DE SU MUEBLE

Indicaciones de limpieza y conservación

- Para limpiar correctamente su muebles de madera, siempre use un paño húmedo.
- No se olvide de secar su muebles! No debe permanecer húmedo, pues el agua puede perjudicar el acabado o causar moho en la madera.
- No es recomendable utilizar productos con amoníaco.
- No utilizar esponjas de acero o cualquier material que dañe la superficie de los muebles.
- No utilizar plásticos o papeles coloridos para forrar los muebles.
- Evite arrastrar objetos encima de los muebles. Ellos pueden riscar o dañar el acabado de su mueble de cocina.
- El material de los muebles tiene un tratamiento contra los hongos y las polillas, aun así, en ambientes infectados, se recomienda desinfectar antes de instalar su mueble.
- Evite la exposición directa al sol. Se sugiere la utilización de cortinas para proteger sus muebles.

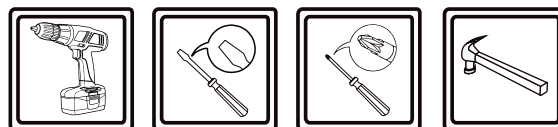
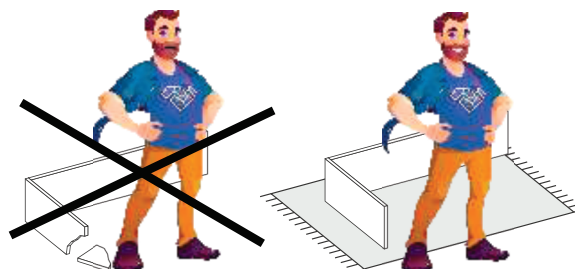

As ferramentas necessárias para montagem do produto não são fornecidas.
The necessary tools for assembly aren't supplied.

Las herramientas necesarias para armar los productos no son fornecidas.

N°	CÓDIGO CODE CÓDIGO	DESCRIÇÃO DESCRIPTION DESCRIPCIÓN			DIMENSÃO (mm) DIMENSION (mm) DIMENSIÓN (mm)			QUANTIDADE QUANTITY CANTIDAD
					COMP. LEN. LON.	LARG. WID. ANC.	ESP. DEP. ESP.	
PAINEL 1800								
1	12922	Painel ripado	Panel	Panel	1350	447	24	3
2	13490	Painel ripado passa fio	panel with wire pass	Panel con paso de alambre	1350	447	24	1
3	12907	Moldura do painel	Panel frame	Marco del panel	350	70	15	10
4	12915	Moldura fechamento lateral	Lateral closing frame	Marco de cierre lateral	1350	26	12	2
5	12909	Moldura da parede	Wall frame	Marco de pared	850	70	15	4
6	12923	Painel ripado extensão	Panel	Panel	1350	349	24	1

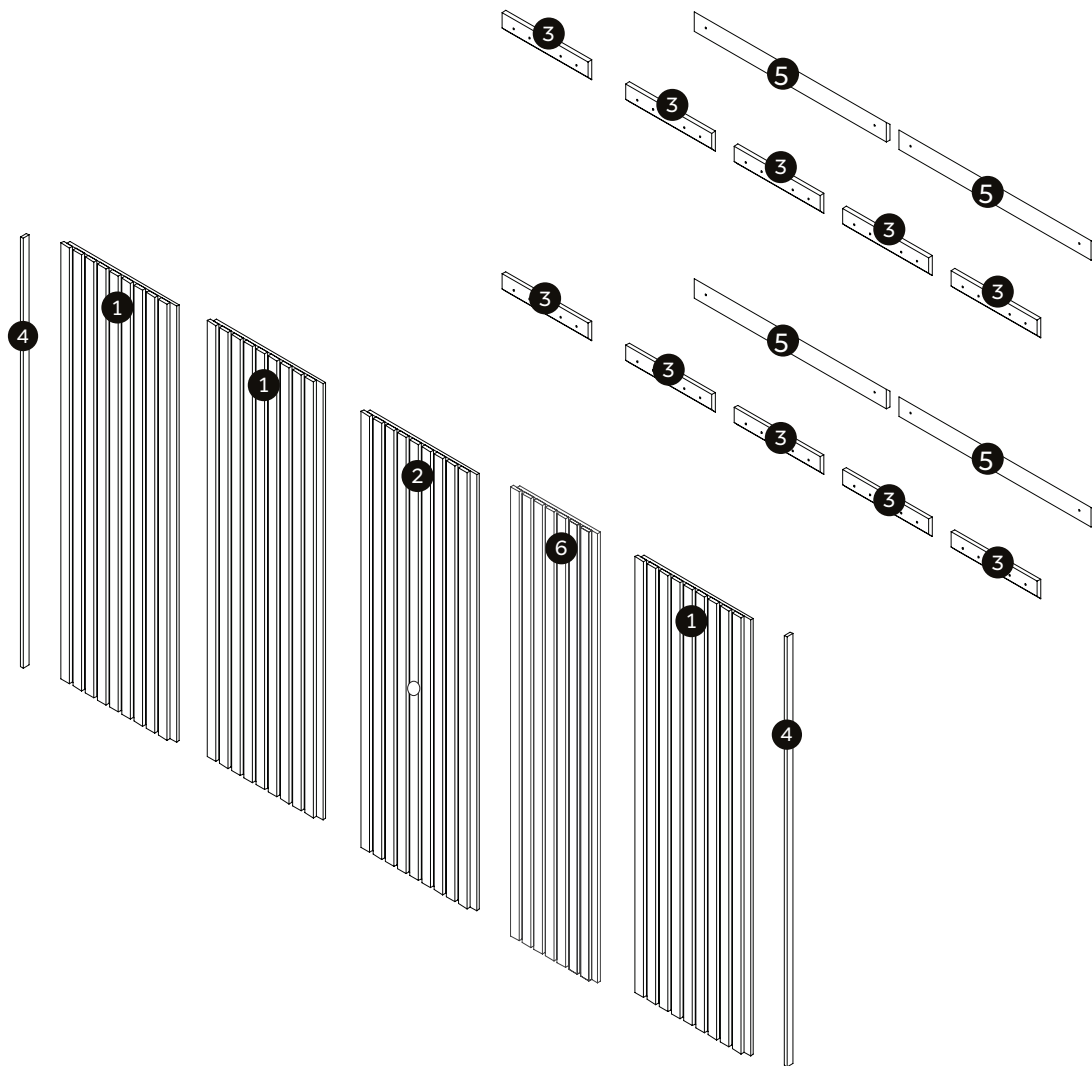

VERSÃO 2200

A2 - CAVILHA MADEIRA 6X25 20
8X25 WOODEN DOWEL
TARUGO DE MADEIRA 6X25



B9 - PARAFUSO 6,0X70MM 12
6,0X70MM SCREW
TORNILLO 6,0X70MM

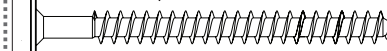

B10 - PARAFUSO 4,0X22MM 35
4,0X22MM SCREW
TORNILLO 4,0X22MM

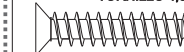

B11 - PARAFUSO 3,5X12MM 16
3,5X12MM SCREW
TORNILLO 3,5X12MM

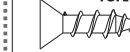

E1 - TAPA FURO ADESIVO 12MM 02
ADHESIVE HOLE COVER 12MM
TAPA AGUJERO ADHESIVO 12MM



E5 - PASSA FIO 01
WIRE THREADER
PASSA FIO



KIT OPCIONAL

B17 - PARAFUSO 3,5X12MM 03
3,5X12MM SCREW
TORNILLO 3,5X12MM

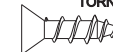

C2 - FIXADOR DE CABOS 03
CABLE FIXER
FIJADOR DE CABLES



H2 - PERFIL DIFUSOR 03
DIFFUSER PROFILE
PERFIL DIFUSOR

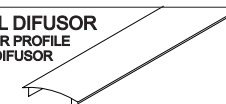

I11 - KIT LED 01



I3 - GIZ PARA RETOQUE 01
TOUCH-UP CHALK
TIZA DE RETOQUE



I4 - CONECTOR 2 FUROS 08
CONNECTOR
CONECTOR



I10 - COLA BRANCA 03
WHITE GLUE
COLA BRANCA



I12 - BUCHA DE NYLON 10mm 12
NYLON WALL 10mm
BUCHA DE NYLON 10mm

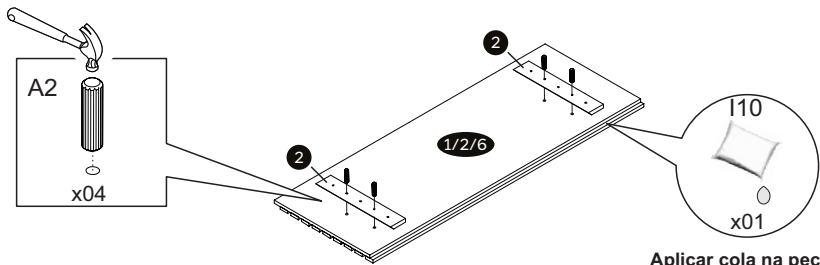

1

Aplicar cola na peça 2.
Apply glue to part 2.
Aplicar pegamento la pieza 2.

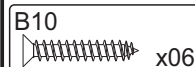
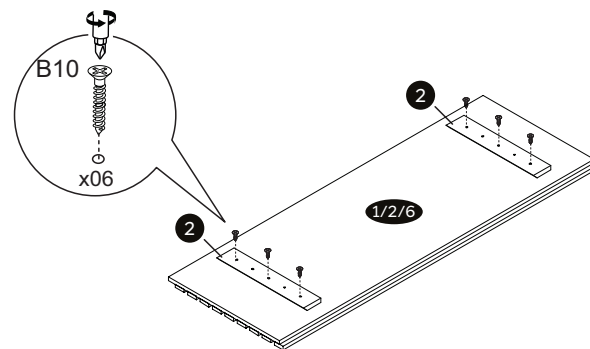
**2****3**

! SOMENTE PARA PAINEL LATERAL
ONLY FOR SIDE PANEL
SOLO PARA PANEL LATERAL

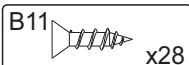
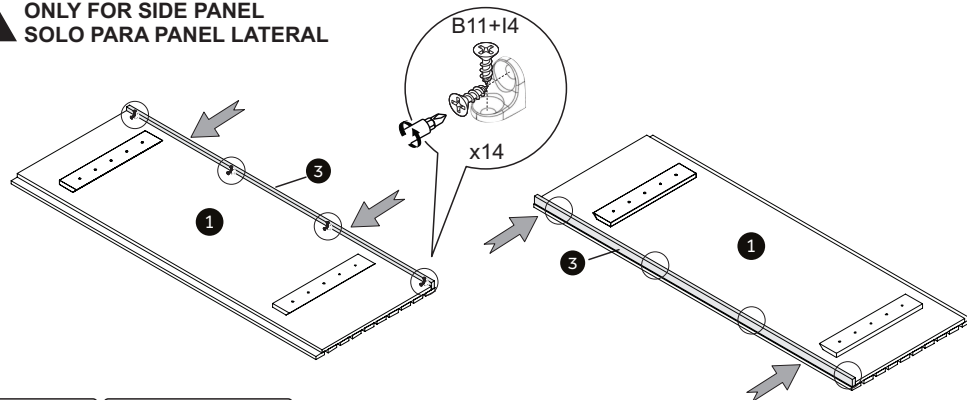
**4**

- Ø 10mm (5/16 ").
- ▾ 50mm (1.96 ").

!
Atenção!
Medida especificada entre os centros dos furos.
Attention!
Specified measurement between the centers of the holes.
¡Atención!
Medida especificada entre los centros de los agujeros.

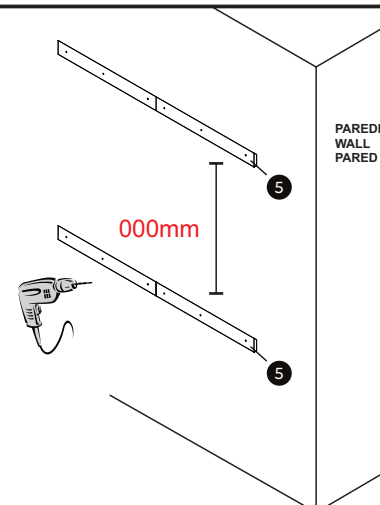
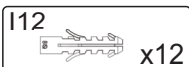
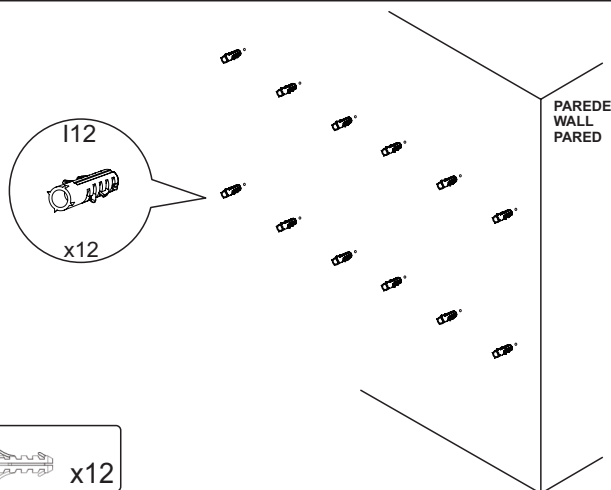
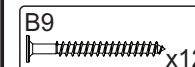
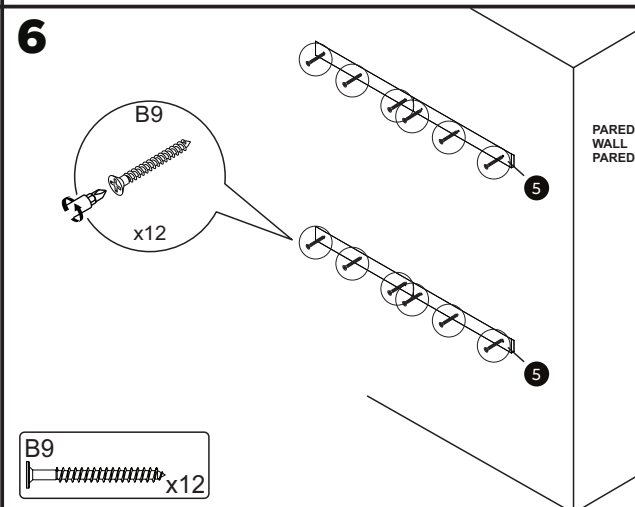
**5****6**

7  **SOMENTE PARA MONTAGEM COM KIT LED OPCIONAL.**
ONLY FOR ASSEMBLY WITH OPTIONAL LED KIT.
SOLO PARA MONTAJE CON KIT LED OPCIONAL.

RETIRE A PELÍCULA PROTETORA DA FITA DUPLA FACE E INICIE A COLAGEM DA FITA DE LED NO CANAL DA PEÇA 1.

REMOVE THE PROTECTIVE FILM FROM THE DOUBLE-SIDED TAPE AND START ATTACHING THE LED TAPE IN THE CHANNEL OF PART 1.

RETIRE LA PELÍCULA PROTECTORA DE LA CINTA DE DOBLE CARA Y COMIENCE A FIJAR LA CINTA LED EN EL CANAL DE LA PARTE 1.

Dica:
Nessa etapa, passe todas as fiações necessárias.

Consejo:
En este paso, pase todo el cableado necesario.

Tip:
In this step, pass all the necessary wiring.

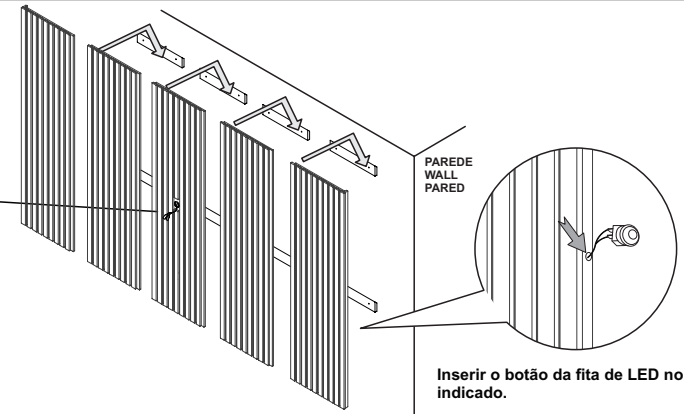
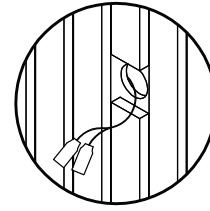
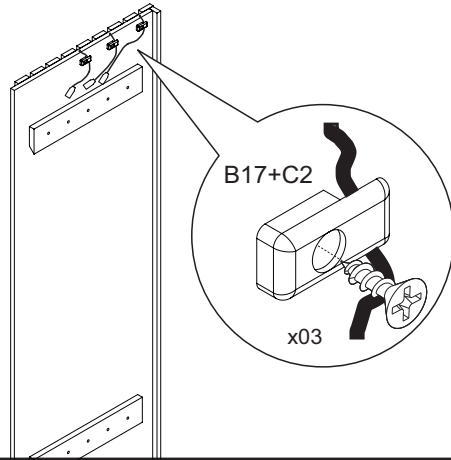
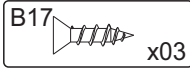
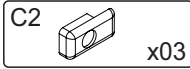

Inserir o botão da fita de LED no furo indicado.

Insert the LED strip button into the indicated hole.

Inserte el botón de la tira LED en el orificio indicado.

8

KIT LED OPCIONAL

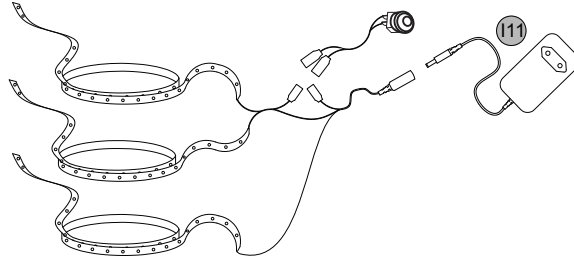
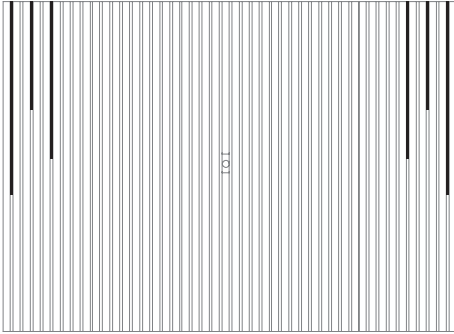

Instalado nos painéis laterais.
Installed on the side panels.
Instalado en los paneles laterales.

Após instalar a fita de Led. Encaixar o perfil de acabamento do Led.
After installing the LED strip. Fit the LED finishing profile.

Después de instalar la tira de LED. Montar el perfil de acabado LED.

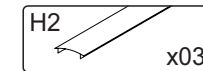
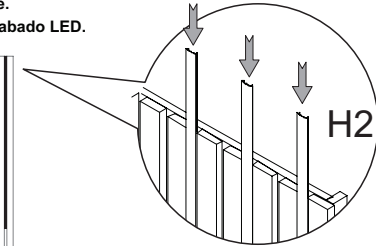
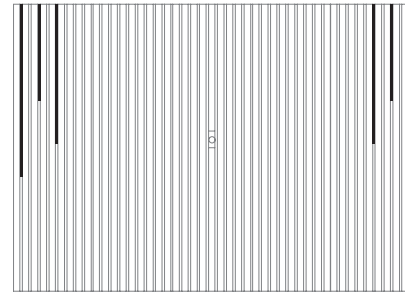

9

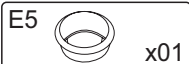
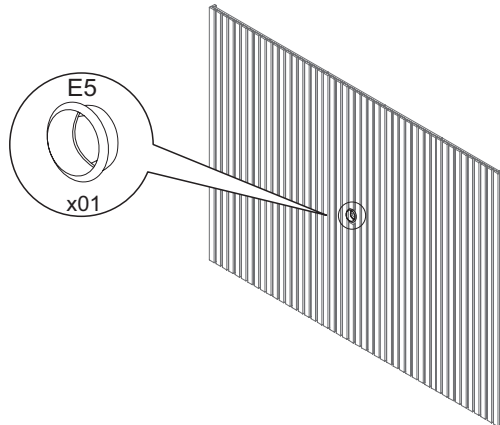

10

