

CADEIRA HAVAÍ PREMIUM

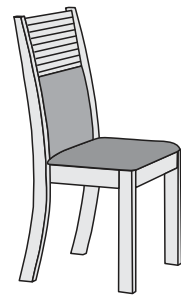

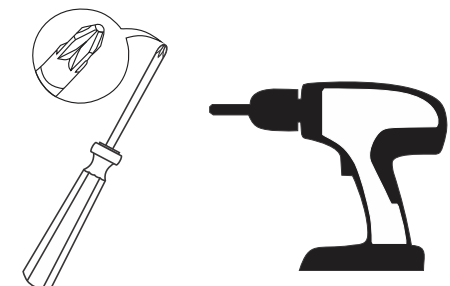







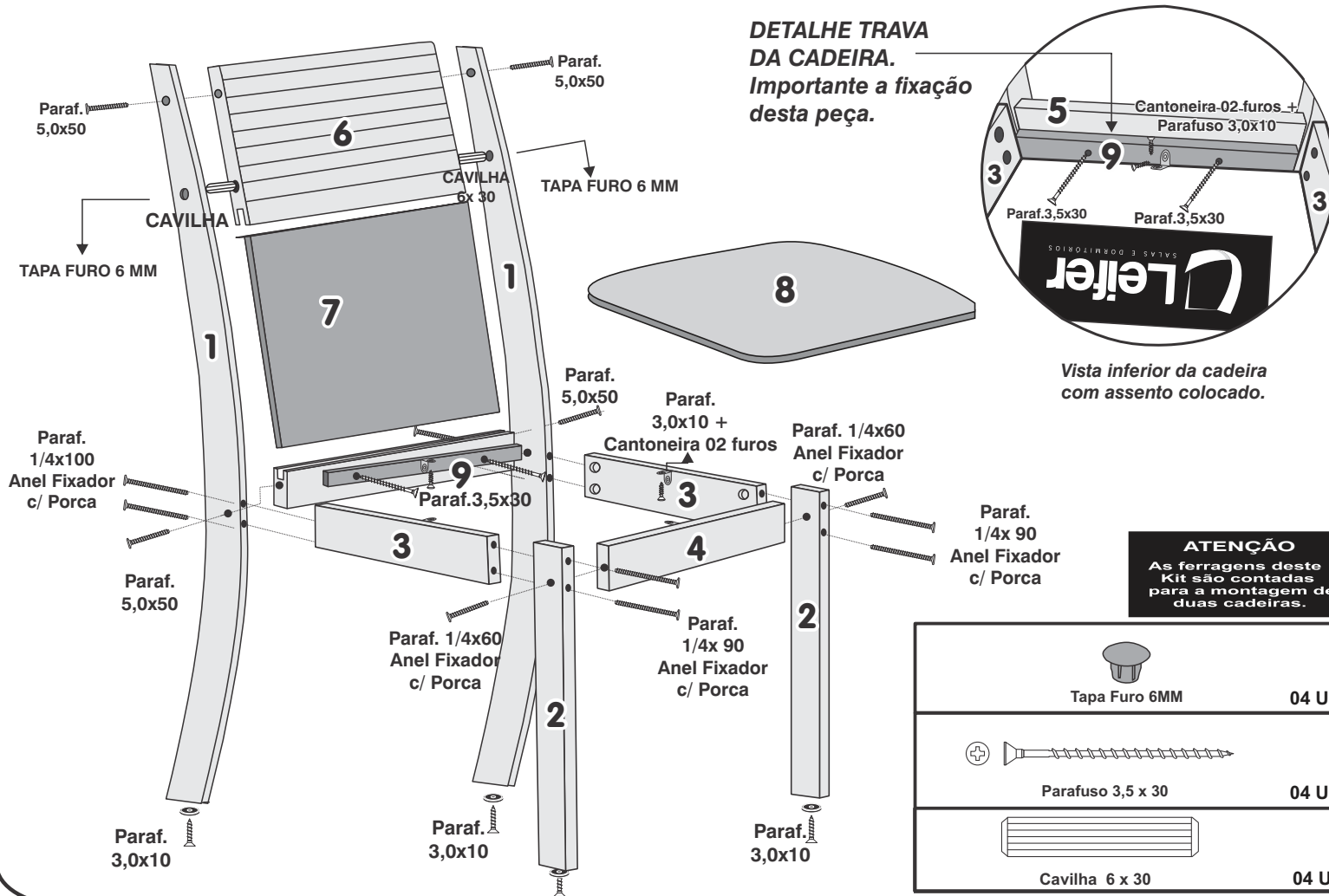



Ferramentas Necessárias:

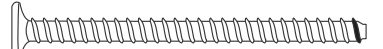

ESQUEMA DE MONTAGEM

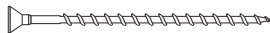
19/03/2020

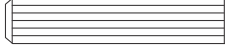

	Parafuso 5,0 x 50	04 UN
	Tampa Parafuso 13mm	24 UN
	Anel Fixador com porca	24 UN
	1/4 x 90 Cabeça 13	16 UN
	1/4 x 60 Cabeça 13	08 UN
	Cantoneiras Montagem Assento	08 UN
	Tapa Furo 6MM	04 UN
	Parafuso 3,0 x 10	24 UN
	Parafuso 3,5 x 30	04 UN
	Sapatas	08 UN
	Cavilha 6 x 30	04 UN
	Tampa Parafuso 10mm	04 UN

CADEIRA HAVAI PREMIUM

CÓD. 14841

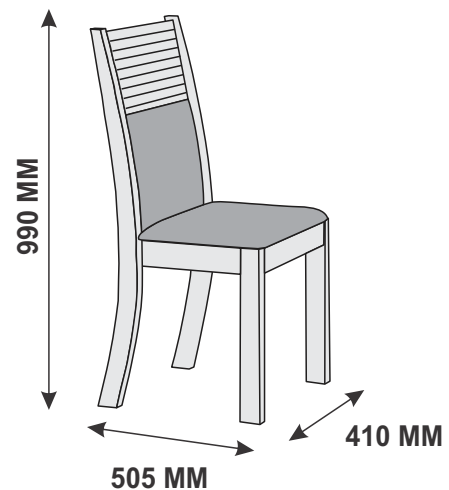

CÓDIGO	Nº	DESCRIÇÃO	QT.	YPÊ	CANELA	IMBUIA	BRANCO	
15121	01	PÉ TRASEIRO	02	15121	15121	15121	15121	
12993	01	PÉ FRONTAL CADEIRA	04	12993	12993	12993	12993	
05991	02	PINÁZIO FRONTAL	02	05991	05991	05991	05991	
05989	03	PINÁZIO LATERAL	04	05989	05989	05989	05989	
15122	04	PINÁZIO TRASEIRO	02	15122	15122	15122	15122	
05996	05	ENCOSTO ESTOFADO	02	05996	05996	05996	05996	
05987	06	PINÁZIO SUPERIOR	02	05987	05987	05987	05987	
05995	07	ASSENTO ESTOFADO	02	05995	05995	05995	05995	
15176	08	KIT FERRAGEM	01	15176	15176	15176	15176	
15124	09	TRAVA DA CADEIRA	02	15124	15124	15124	15124	