



SALAS E DORMITÓRIOS

Av. das Indústrias, nº 157 - Bairro Belo Horizonte - Rodeiro /MG
Fone/Fax (32) 3577 - 3950

www.leifermoveis.com.br - assistencia@leifermoveis.com.br

ROUPEIRO NITERÓI

código - 18983

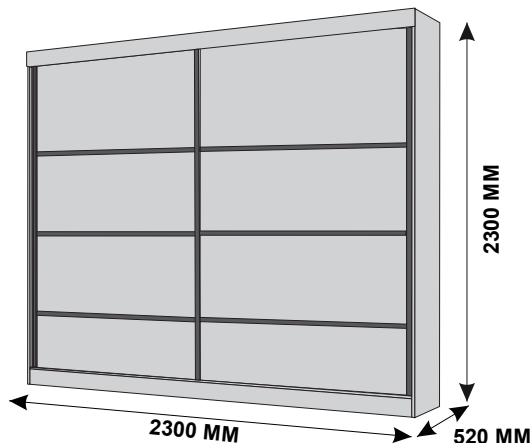

Ferramentas Necessárias:

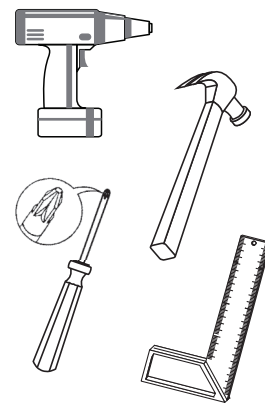

ESQUEMA DE MONTAGEM

31/08/2022

<p>MONTAGEM ESTRUTURA ROUPEIRO</p> <p>Parafuso 4,0 x 40 cabeça chata 46 UN</p>	<p>Parafuso 3,5 x 12 cabeça chata 134 UN</p>	<p>Fixar Costa</p> <p>Prego 10 x 10 120 UN</p>
<p>MONTAGEM GAVETAS E DISTANCIADORES</p> <p>Parafuso 3,5 x 35 cabeça chata 66 UN</p>		
<p>Cavilha 6 x 30 28 UN</p>		<p>Guia Superior Anti Descarrilamento 04 UN</p>
<p>Cantoneira Metálica 10 UN</p>	<p>Suporte Cabide 08 UN</p>	<p>Sapata Plástica 08 UN</p>
<p>GIZ 01 UN</p>	<p>Cantoneira 46x16x16 MOLDURA SUPERIOR 04 UN</p>	<p>Roldana c/ Mola 04 UN</p>
		<p>Etiqueta Leifer 01 UN</p>
		<p>Sachê de Cola 01 UN</p>
		<p>Silicone 08 UN</p>

Nº	DESCRIÇÃO	QT.	CÓD. FREIJÓ	CÓD. BRAÚNA	CÓD. BRANCO
01	RODAPÉ FRONTAL	01	19247	19247	19247
01.1	RODAPÉ TRASEIRO	01	19248	19248	19248
02	RODAPÉ CENTRAL	02	19246	19246	19246
03	BASE	01	19235	19235	19235
04	LATERAL ESQUERDA	01	19241	19241	19241
05	LATERAL DIREITA	01	19240	19240	19240
06	PRATELEIRA	02	19245	19245	19245
07	DIVISÓRIA ESQUERDA	01	19238	19238	19238
08	DIVISÓRIA DIREITA	01	19237	19237	19237
09	DIVISÓRIA CENTRAL	01	19236	19236	19236
10	PRATELEIRA MENOR	02	19233	19233	19233
11	PRATELEIRA CENTRAL MALEIRO	01	19231	19231	19231
12	PRATELEIRA DO MALEIRO	02	19232	19232	19232
13	DISTANCIADOR DE GAVETA	08	19264	19264	19264
14	TAMPO SUPERIOR	01	19249	19249	19249
15	MOLDURA SUPERIOR	01	19242	19242	19242
16	COSTAS	05	19228	19228	19228
17	PERFIL H	04	12271	12271	12271
18	CALCEIRO	02	12272	12272	12272
19	CABIDEIRO	02	12273	12273	12273
20	PORTA C/ ESPELHO	01	19293	19293	19293
21	PORTA S/ ESPELHO	02	19292	19292	19292
22	FRENTE DE GAVETA	04	19229	19229	19229
23	LATERAL DE GAVETA	08	19239	19239	19239
24	FUNDO DE GAVETA	04	19227	19227	19227
25	TRASEIRO DE GAVETA	04	19234	19234	19234
26	TRILHO SUPERIOR	01	12274	12274	12274
27	TRILHO INFERIOR	01	12275	12275	12275
28	PERFIL PUXADOR	02	15649	15649	15649
29	PERFIL ARREIMATE	04	15648	15648	15648
30	PERFIL UNIAO	06	12271	12271	12271
31	KIT DE FERRAGEM	01	12279	12279	12279

Montagem da Base:

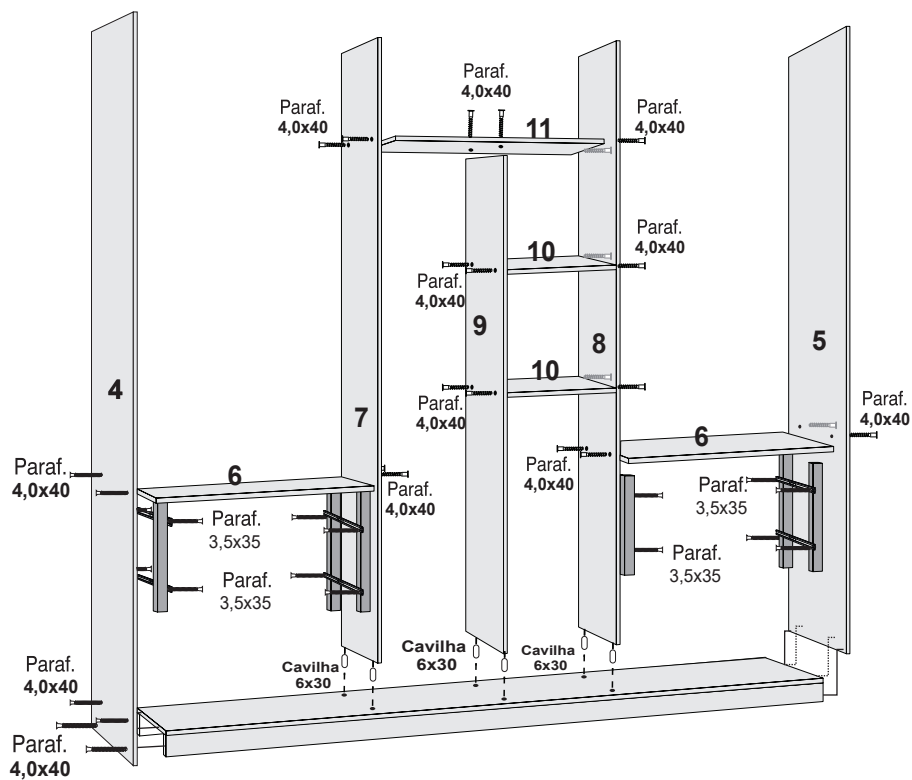
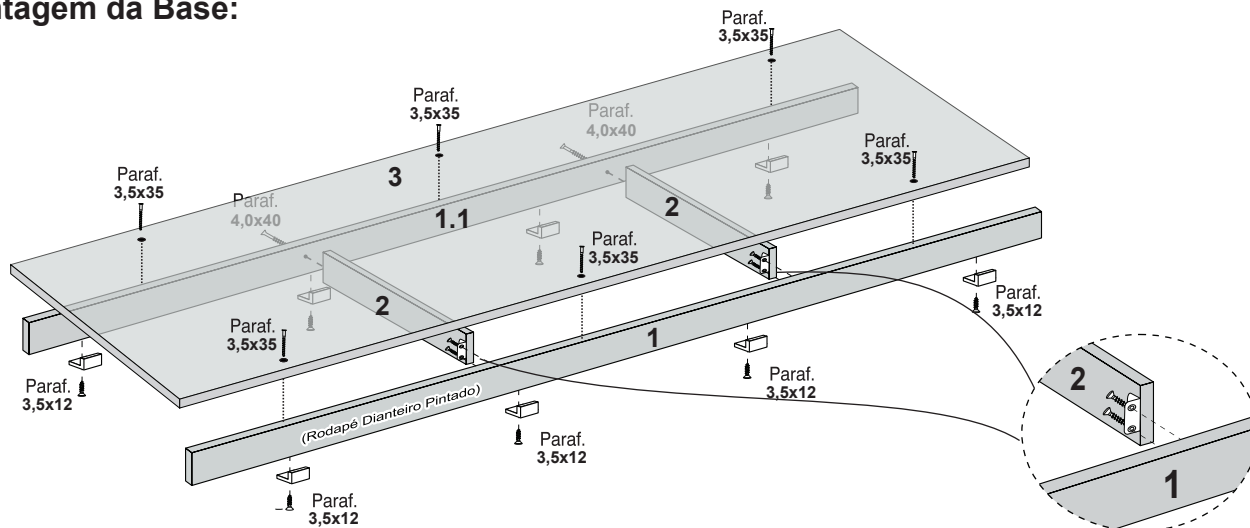

FIXAÇÃO DAS CORREDIÇAS

FAVOR RESPEITAR A MARCAÇÃO NAS DIVISÓRIAS

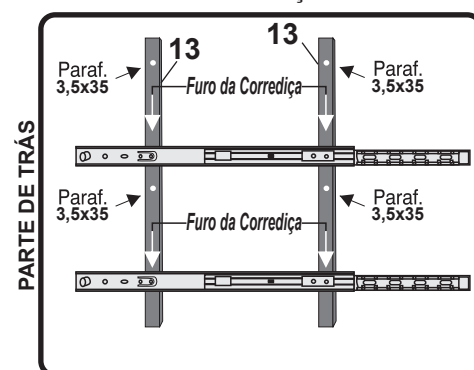

DIVISÓRIA DO ROUPEIRO DO ROUPEIRO

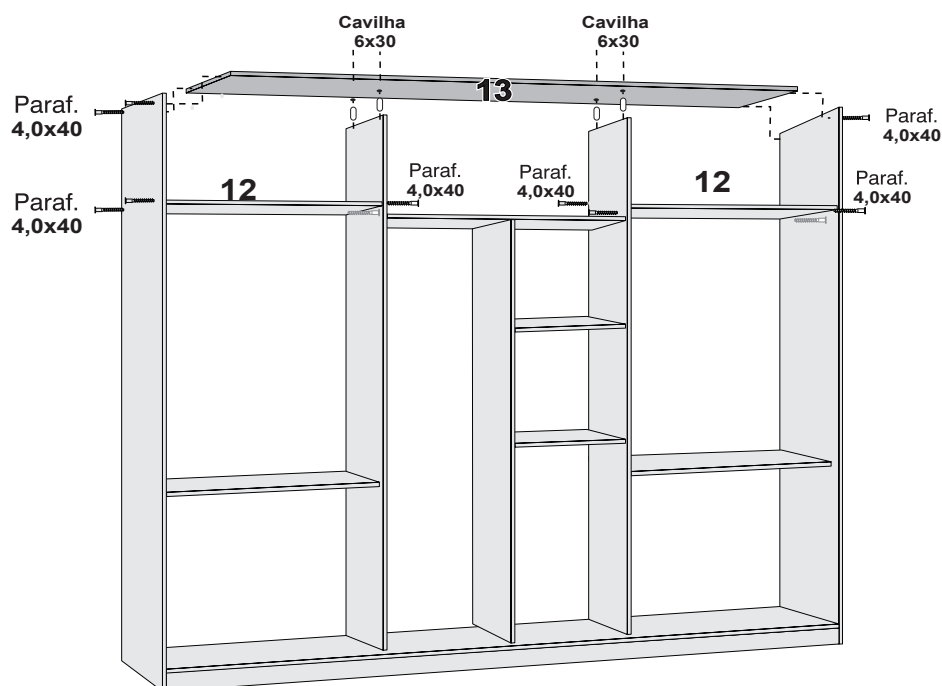

ATENÇÃO SR. MONTADOR MONTAGEM DA MOLDURA SUPERIOR

Montagem da Moldura Superior nº 15 no Tampo Superior nº 14 usando CANTONEIRA METÁLICA EMBALAGEM SEPARADA NA FERRAGEM COM OBSERVAÇÃO, parafusando no rasgo da moldura e usando parafuso 3,5x12 .

Cantoneira Metálica

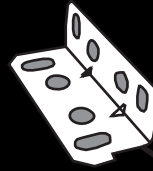

Encaixar o furo da cantoneira no rasgo da moldura e fixar a cantoneira com parafuso 3,5 x 12

ATENÇÃO USAR AS CANTONEIRAS MAIORES NA MOLDURA

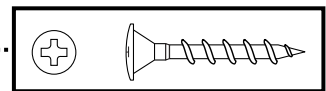

Parafuso 3,5 x 12

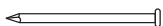
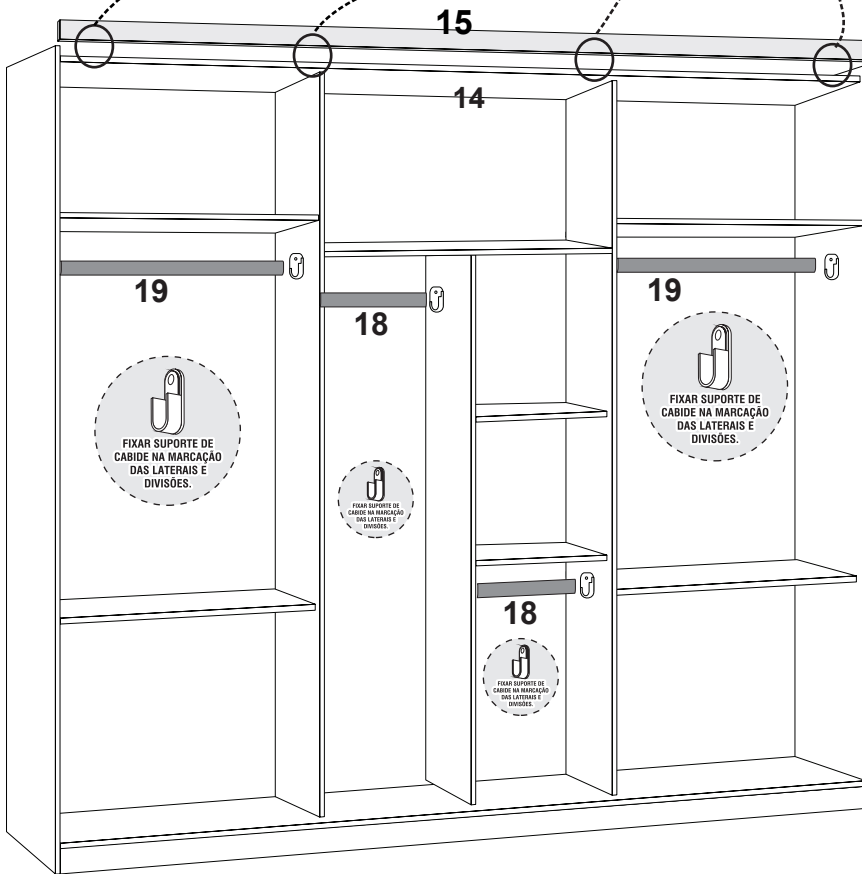

Fixar Costa
Prego 10 x 10

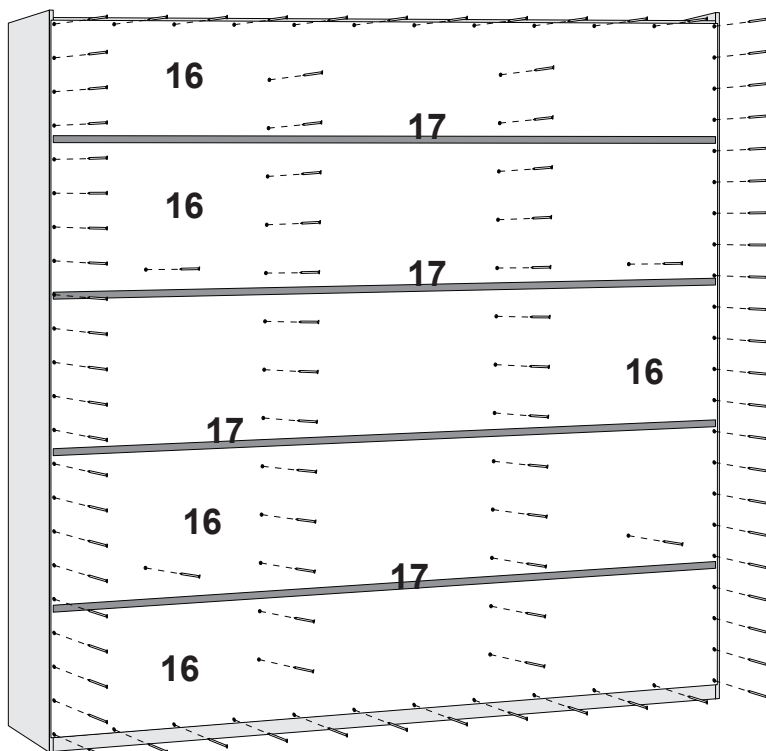
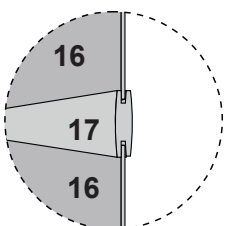
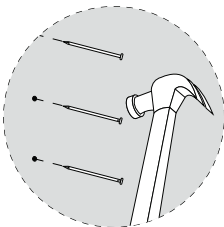

ATENÇÃO:
ENCOSTAR O GUIA NA
MOLDURA E FIXAR O MESMO
COM PARAF. 3,5X12

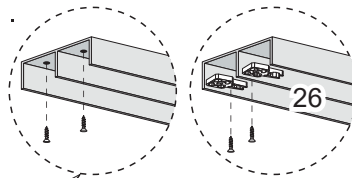

Parafuso 3,5 x 14

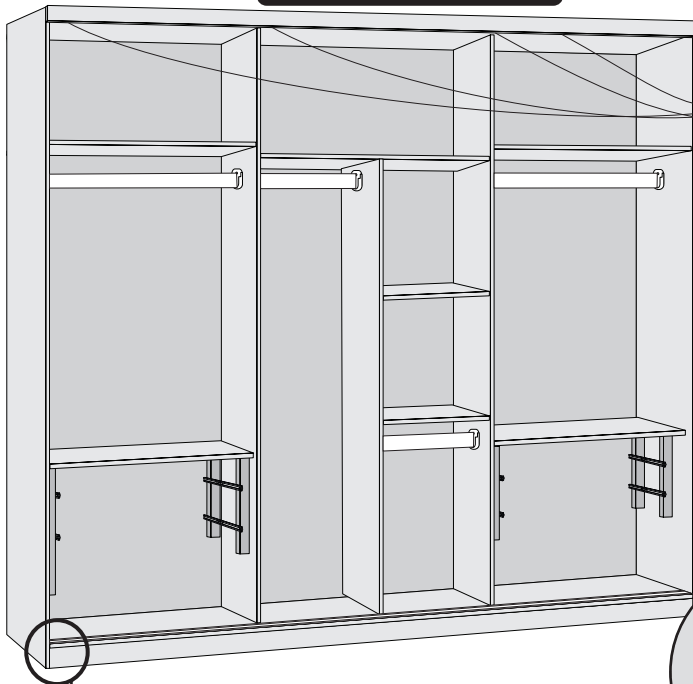

PARAFUSAR TRILHO INFERIOR DE ALUMÍNIO NA BASE
USANDO PARAFUSO 3,5 X 14, NOS FUROS DO TRILHO.

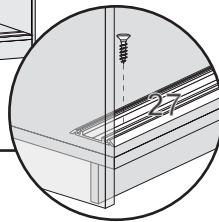

**PORTA
LATERAL**

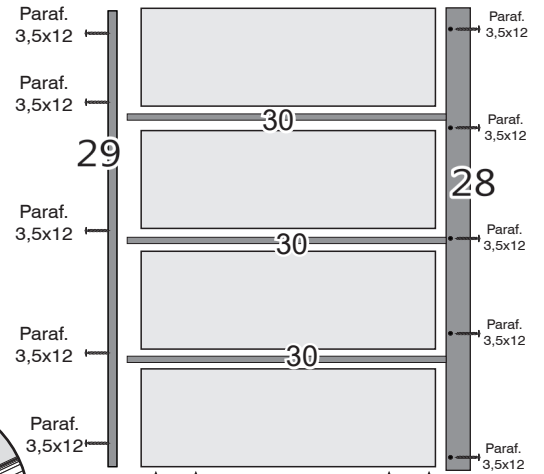

FIXAR ROLDANA
NAS EXTREMIDADES
DA PORTA E USAR PARAFUSO 3,5 X 12

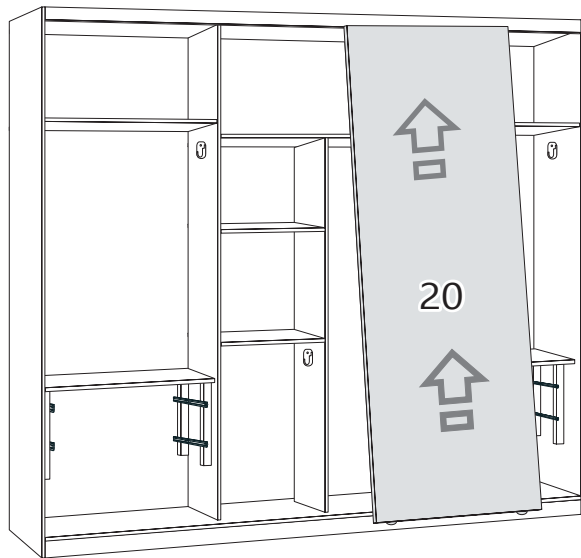

ENCAIXE DAS PORTAS.

PRIMEIRO ENCAIXE A PORTA NO GUIA SUPERIOR
E EM SEGUIDA ENCAIXE NO TRILHO INFERIOR,
ALINHE A PORTA E PARAFUSE O TRILHO.

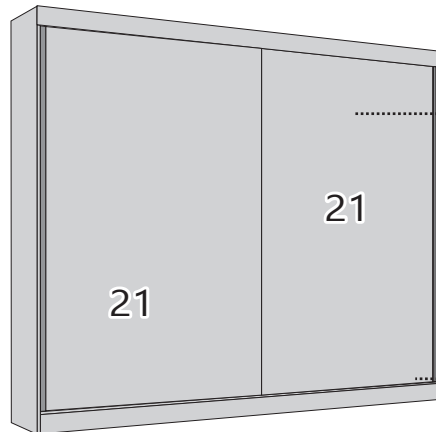

Parafusar as roldanas metálicas
com molas na parte inferior da
porta.
Parafusar os guias superiores
com rolamento um em cada
extremidade na parte superior.

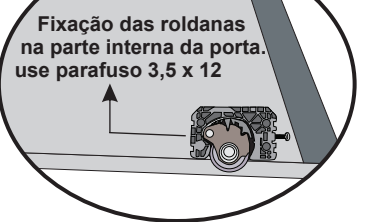
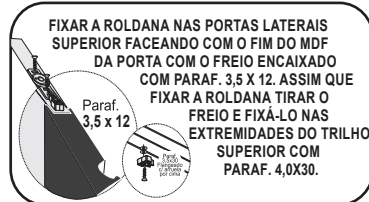

**MONTAGEM
DAS GAVETAS**

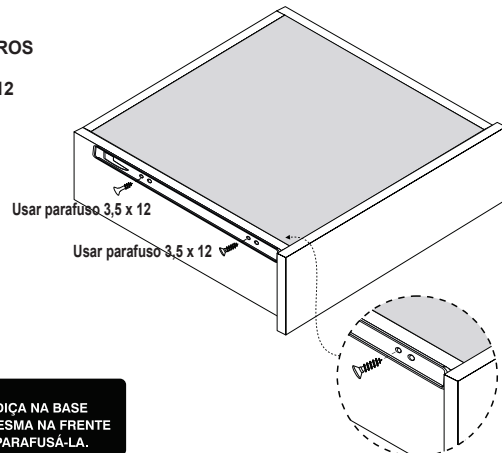
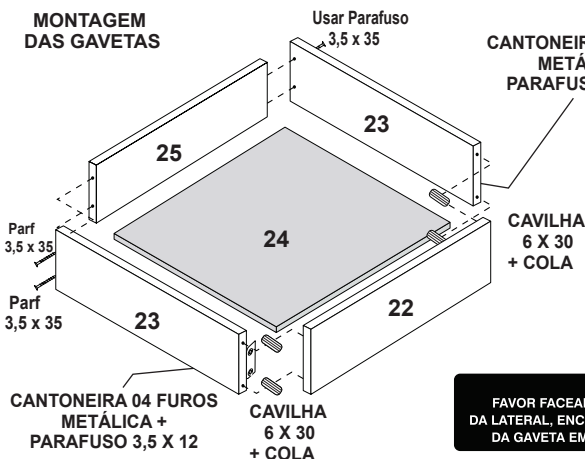

ATENÇÃO:
FAVOR FACEAR A CORREDIÇA NA BASE
DA LATERAL, ENCOSTAR A MESMA NA FRENTE
DA GAVETA EM SEGUIDA PARAFUSÁ-LA.