



ROUPEIRO NAPOLI

Cód.: 8752

Benetil
Móveis

Av. Jesus Candian, 395 - B. Mangueira Rural

Telefax (32) 3539-5350

CEP 36500-000 - Ubá - Minas Gerais

www.benetil.com.br

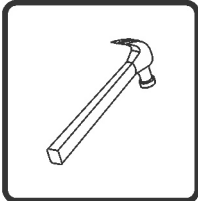
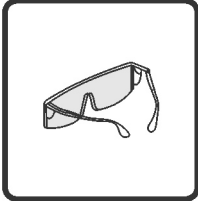
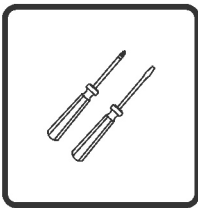

32 3539.5350
www.benetil.com.br

DETALHES IMPORTANTES

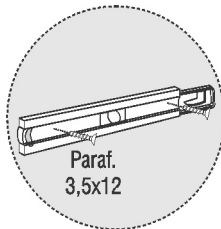

Corredixa Telecópica

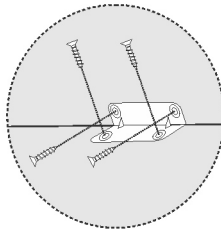

Cantoneira 4 Furos

COMPONENTES

NUM.	PEÇA	QUANT.
01	LATERAL ESQUERDA	01
02	RODAPÉ MAIOR	02
03	RODAPÉ MENOR	02
04	LATERAL DIREITA	01
05	BASE	01
06	DIVISÃO ESQUERDA	01
07	DIVISÃO MENOR CENTRAL	01
08	PRATELEIRAS MAIORES	04
09	PRATELEIRA INTERMEDIARIA	01
10	PRATELEIRAS MENORES	04
11	TAMPO SUPERIOR	01
12	VISTA SUPERIOR	01
13	VISTA LATERAL	02
14	PORTAS	06
15	COSTAS VERTICAL	03
16	FRENTE GAVETA	06
17	LATERAL GAVETA	12
18	TRASEIRO GAVETA	06
19	FUNDO GAVETA	06
20	DIVISÃO DIREITA	01
21	PÉS	08

ATENÇÃO: EM CASO DE ASSISTÊNCIA, VERIFICAR O NÚMERO DO LOTE DE PRODUÇÃO, NO TOPO DAS PEÇAS E NA ETIQUETA DA CAIXA DO PRODUTO.

**RESERVAMO-NOS O DIREITO DE EFETUAR MODIFICAÇÕES TÉCNICAS
OU DE MATERIAIS SEM PRÉVIO AVISO.**

RELAÇÃO DE FERRAGENS EM TAMANHO REAL (MEDIDA EM MILÍMETRO).



A - PARAF. 3,5x14



B - PARAF. 5x40

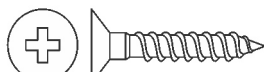

C - PARAF. 4,0x25

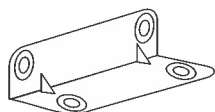

D - CANTONEIRA 4 FUROS



E - FIXADOR DE COSTAS

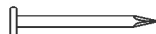

Q - PREGO 10x10

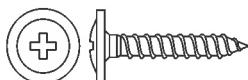

F - PARAF. 3,5x20 FLANGEADO

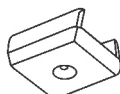

G - SAPATA DE ENCAIXE

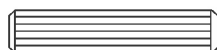

H - CAVILHA 6x30

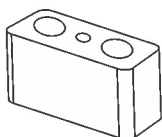

I - ALONGADOR DE CORREDIÇA

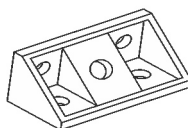

J - CANTONEIRA 4 FUROS



R - TAMPA ADESIVA



K - PUXADOR

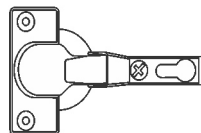

L - DOBRADIÇA



M - CALÇO



N - CABIDEIRO

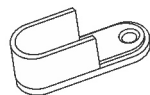

O - SUPORTE CABIDEIRO

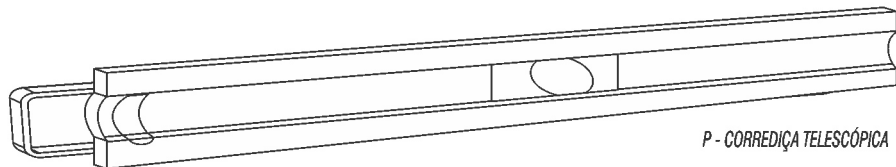

P - CORREDIÇA TELESCÓPICA



UTILIZE A RÉGUA PARA A MEDIÇÃO DOS PARAFUSOS

FAVOR IDENTIFICAR AS PEÇAS E COLOCAR SEUS RESPECTIVOS ACESSÓRIOS

Sequência de Montagem

- 01 - Parafusar peça 2 nas peças 3;
- 02 - Parafusar peças 1 nas peças 4;
- 03 - Parafusar os Pés 21 nas peças 2 e 3 e nas peças 1 e 4.

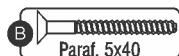

ATENÇÃO COM OS FUROS
NA PARTE SUPERIOR DA
PEÇA 2 AS PEÇAS 3 TEM QUE
ALINHADOS COM OS MESMOS.

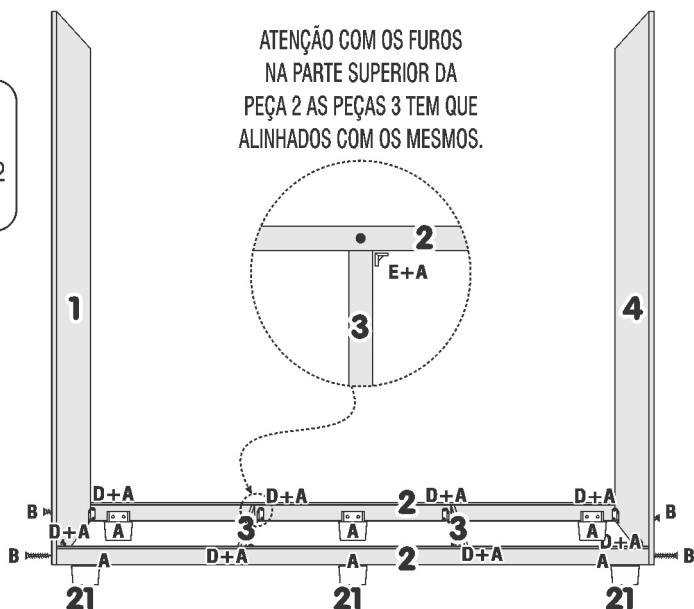

Sequência de Montagem

- 04 - Encaixar e Parafuse peça 5 nos rodapés 2 e laterais 1 e 4;
- 05 - Encaixar peças 6, 7 e 20 na peça 5;
- 06 - Parafusar peças 8 nas peças 1 e 6 e nas peças 4 e 20.

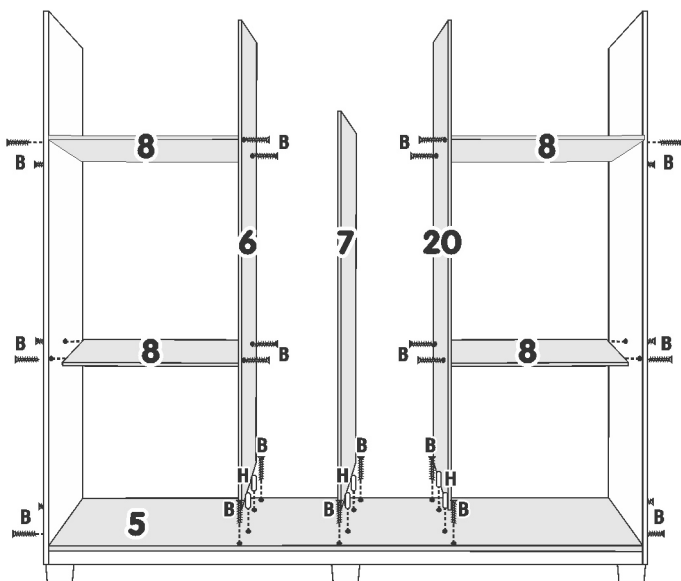
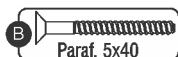

Sequência de Montagem

07 - Parafusar a peça 9 nas peças 6, 7 e 20.

08 - Parafusar as peças 10 nas peças 6, 7 e 20, conforme desenho ao lado.

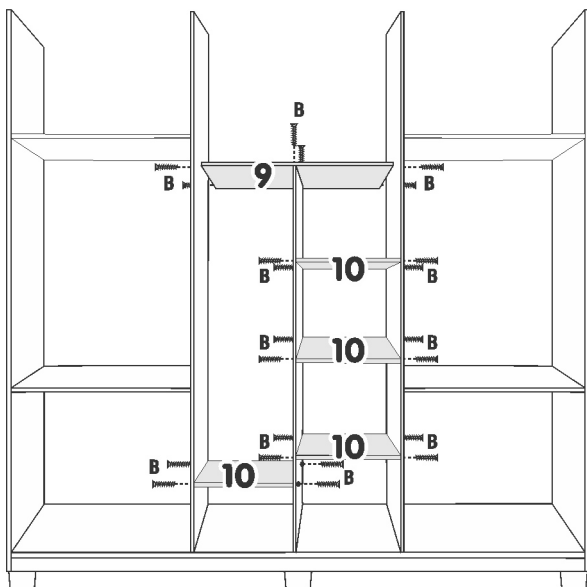
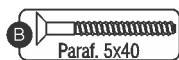

Sequência de Montagem

09 - Encaixar e Parafusar peça 11 nas peças 1, 4, 6 e 20.

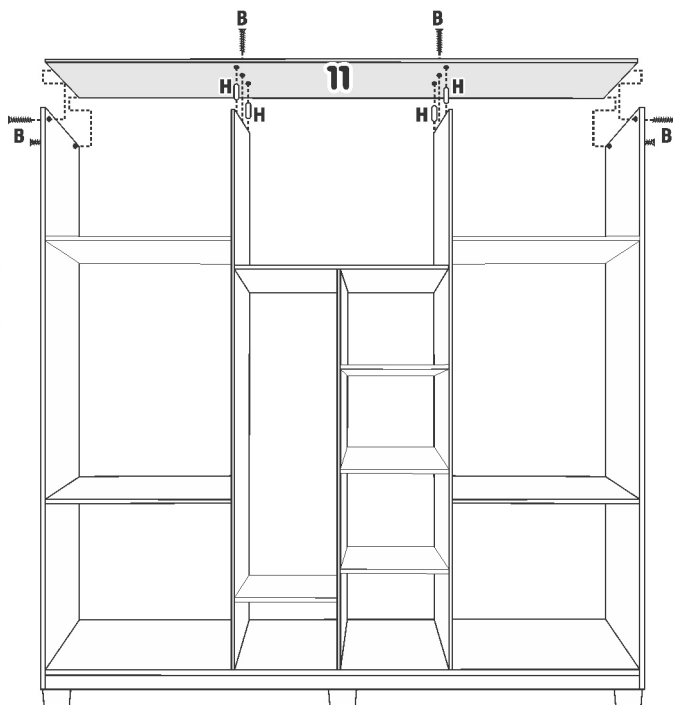
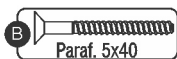

Seqüência de Montagem

- 10 - Fixar peça 12 na peça 1, 4 e também na peça 11;
- 11 - Parafusar alongador de correções(l) das peças 1, 4 e 6.

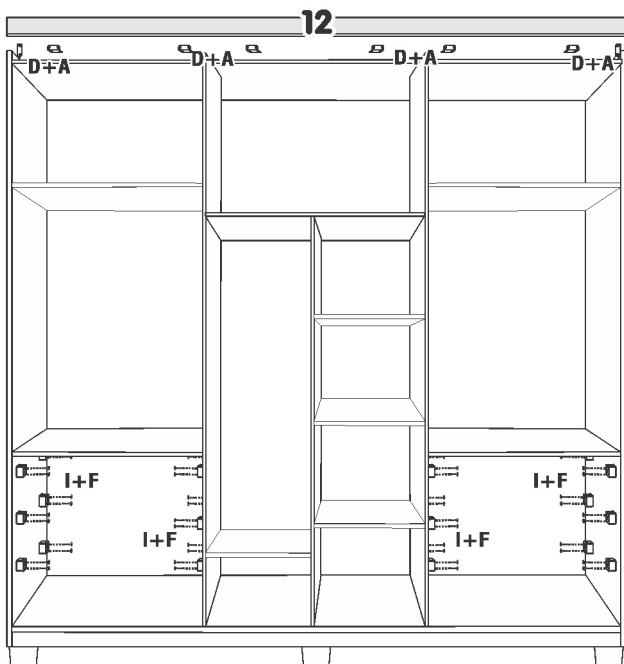

Seqüência de Montagem

- 12 - Montar os cabideiros com os suportes;
- 13 - Parafusar as correções;
- 14 - Parafusar peças 13 nas 1 e 4.

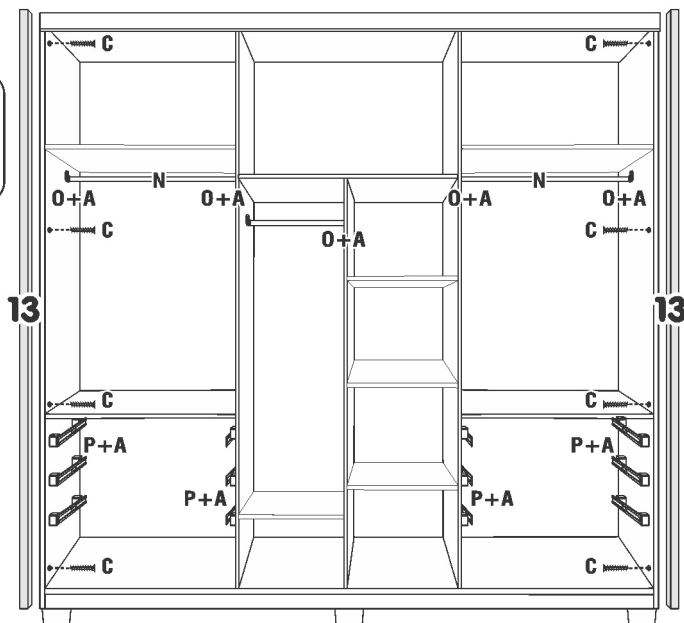
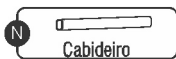

Sequência de Montagem

15 - Pregar as Costas 15 conforme desenho ao lado.

OBS.: Acertar as costas para melhor esquadramento do móvel.

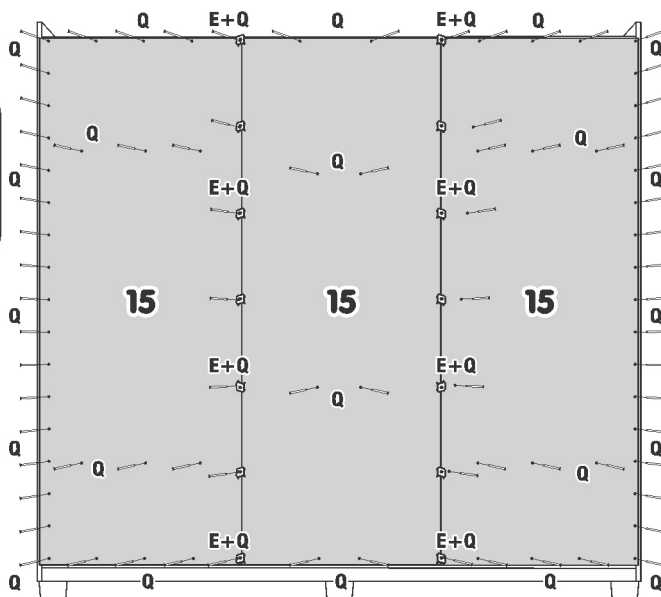
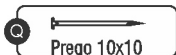
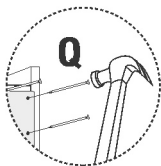

Sequência de Montagem

16 - Montar e fixar as Portas 14.

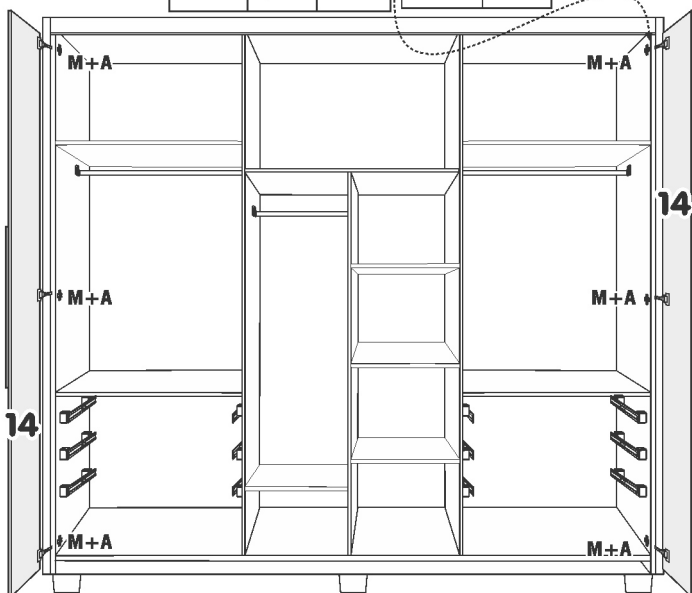
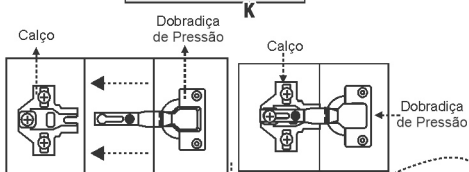
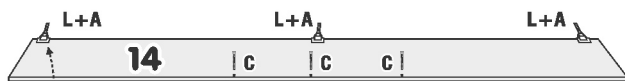
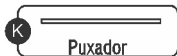
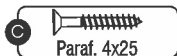
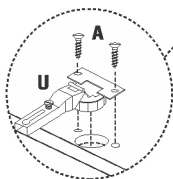

Sequência de Montagem

- 17 - Parafusar as cantoneiras nas peças 17;
- 18 - Parafusar as peças 17 na peça 16;
- 19 - Parafusar a peça 18 nas peças 17;
- 20 - Parafusar peça 19 nas peças 17 e 18 conforme desenho abaixo, ajustando para melhor esquadramento da gaveta;
- 21 - Parafusar as corredeiras na lateral da peça 17;

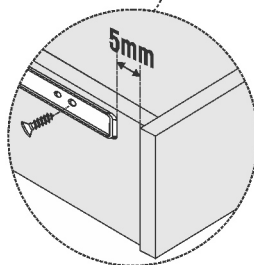
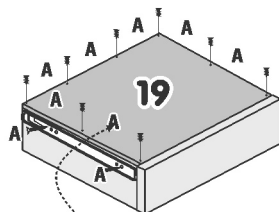
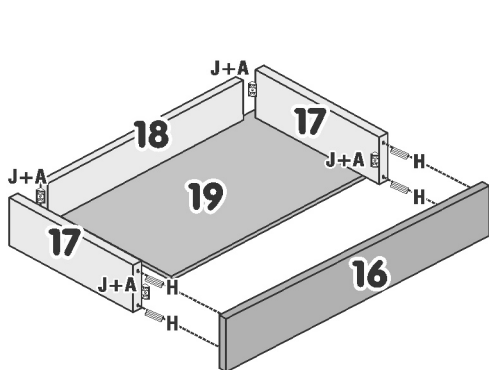

Benetil

Móveis

Av. Jesus Candian, 395 - B. Mangueira Rural

Telefax (32) 3539-5350

CEP 36500-000 - Ubá - Minas Gerais

www.benetil.com.br