

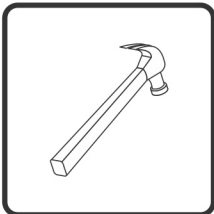

ROUPEIRO COPACABANA NEW 06 PTS
Código: 7540

Benetil
Móveis

Av. Jesus Candian, 395 - B. Mangureira Rural
Telefax (32) 3539-5350
CEP 36500-000 - Ubá - Minas Gerais
www.benetil.com.br

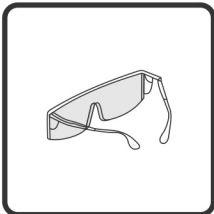
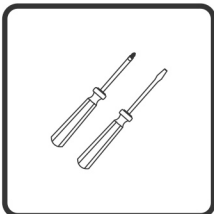

32 3539.5350
www.benetil.com.br

DETALHES IMPORTANTES



Corrediça Telecópica

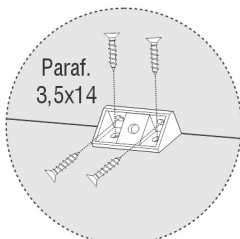

Cantoneira 4 Furos

COMPONENTES		
NUM.	PEÇA	QUANT.
01	LATERAL ESQUERDA	01
02	RODAPÉ MAIOR	02
03	RODAPÉ MENOR	02
04	LATERAL DIREITA	01
05	BASE MENOR	02
06	DIVISÃO MAIOR	01
07	DIVISÃO MENOR	01
08	PRATELEIRA MAIOR	01
09	BATENTE DA PORTA	01
10	PRATELEIRAS	03
11	BATENTE TRASEIRO	01
12	TAMPO SUPERIOR	01
13	VISTA SUPERIOR	01
14	PORTAS MAIORES	04
15	PORTAS MENORES	02
16	FRENTE GAVETAS	02
17	LATERAL DE GAVETAS	04
18	TRASEIRO GAVETAS	02
19	FUNDO GAVETA	02
20	COSTAS	03
21	PÉS	08

ATENÇÃO: EM CASO DE ASSISTÊNCIA, VERIFICAR O NÚMERO DO LOTE DE PRODUÇÃO, NO TOPO DAS PEÇAS E NA ETIQUETA DA CAIXA DO PRODUTO.

RESERVAMO-NOS O DIREITO DE EFETUAR MODIFICAÇÕES TÉCNICAS OU DE MATERIAIS SEM PRÉVIO AVISO.

RELAÇÃO DE FERRAGENS EM TAMANHO REAL (MEDIDA EM MILÍMETRO).



A - PARAF. 3,5x14



B - PARAF. 5x40

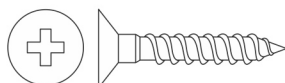

C - PARAF. 4,0x25

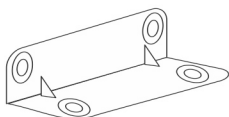

D - CANTONEIRA 4 FUROS

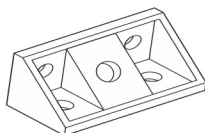

E - CANTONEIRA 4 FUROS

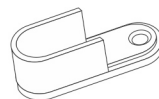

F - SUPORTE CABIDEIRO

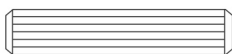

G - CAVILHA 6x30



H - PREGO 10x10

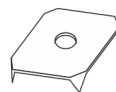

J - FIXADOR DE COSTAS



M - PUXADOR

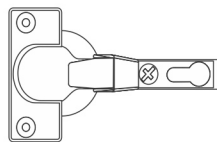

N - DOBRADIÇA

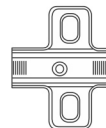

O - CALÇO

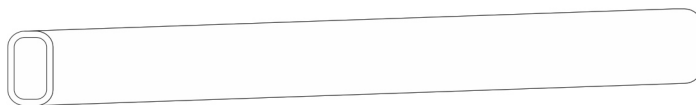

P - CABIDEIRO

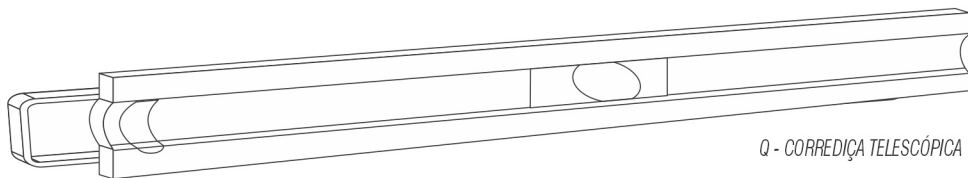

Q - CORREDIÇA TELESCÓPICA

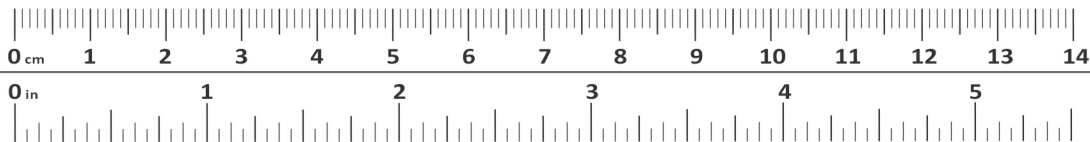

3

UTILIZE A RÉGUA PARA A MEDIÇÃO DOS PARAFUSOS

FAVOR IDENTIFICAR AS PEÇAS E COLOCAR SEUS RESPECTIVOS ACESSÓRIOS

Sequência de Montagem

- 01 - Parafusar peças 2 nas peça 3;
- 02 - Parafusar peça 1 nas 2;
- 03 - Parafusar peça 4 nas peças 2;
- 04 - Parafusar os Pés 22 nos rodapés 2.

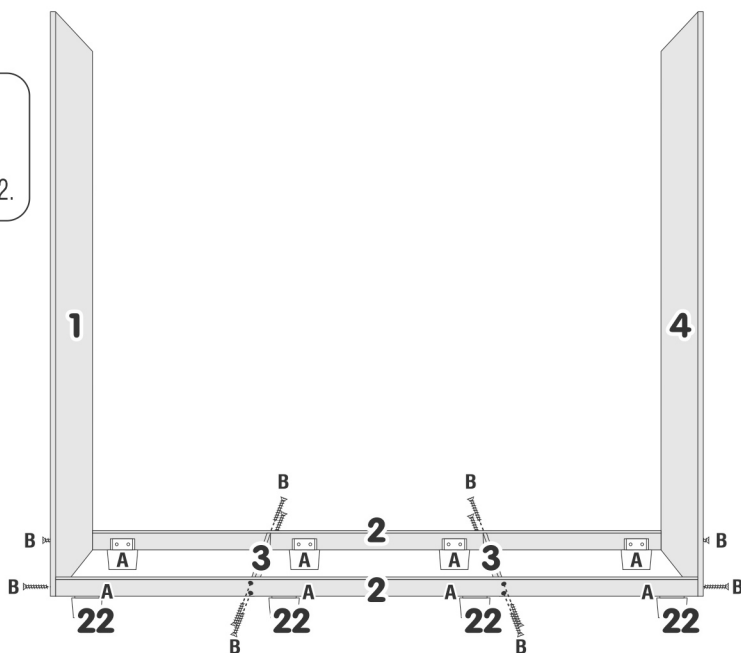
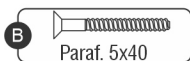

Sequência de Montagem

- 05- Parafusar peça 5 nas peças 2;
- 06- Parafusar as peça 6 e 7 na peça 5 conforme desenho.

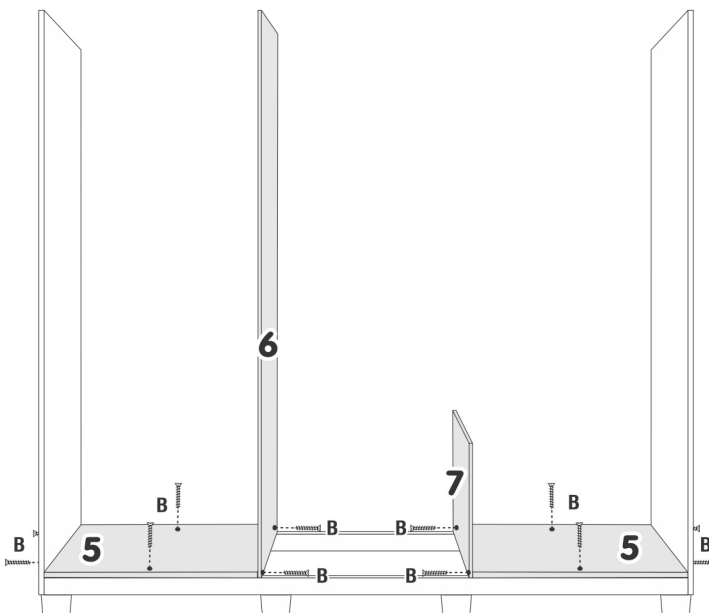
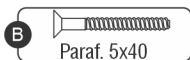

Sequência de Montagem

- 07- Parafusar peça 9 na peça 8;
- 08- Parafusar peça 11 na peça 8.

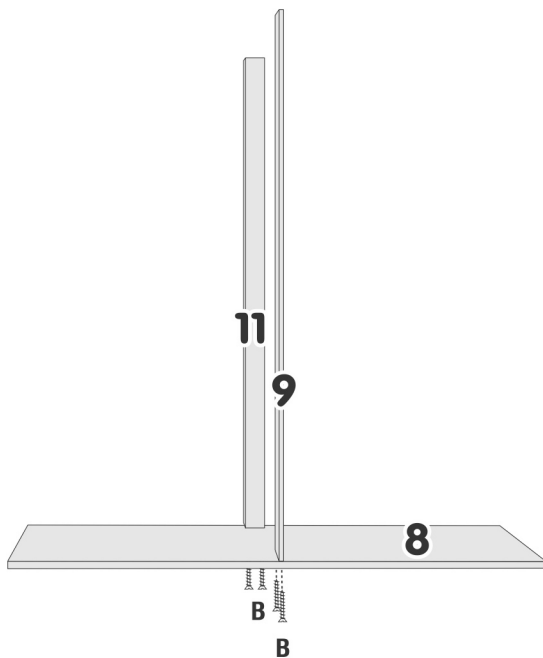
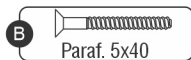

Sequência de Montagem

- 09- Parafusar peça 5 nas peças 4, 6 e 7 conforme desenho.

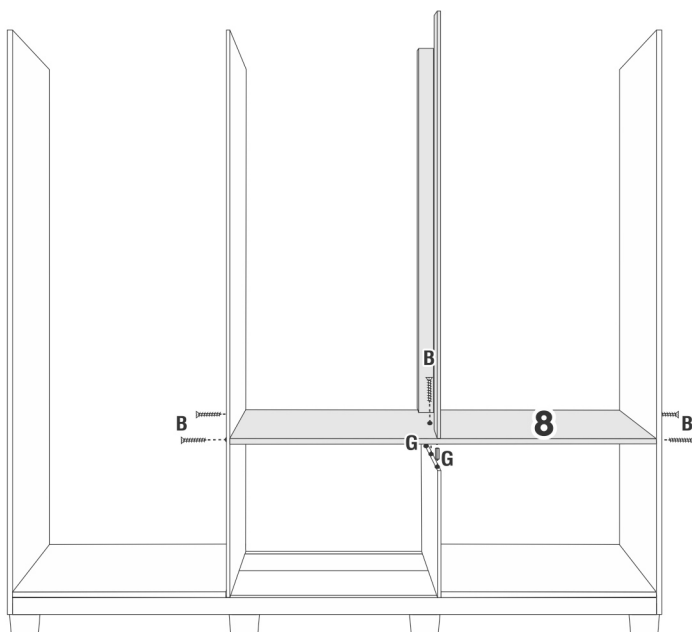
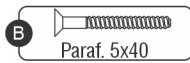

Sequência de Montagem

10 - Parafusar as peças 10 nas peças 1 e 6.

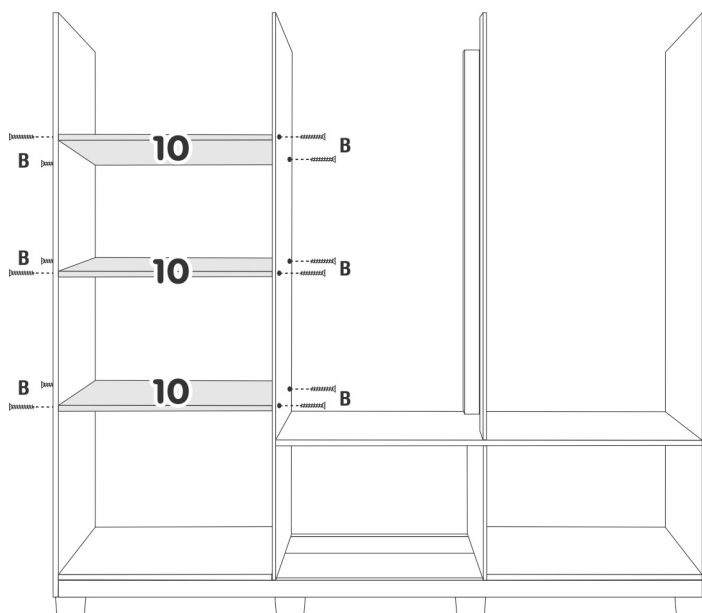
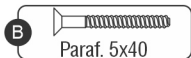

Sequência de Montagem

11 - Parafusar as peças 12 nas peças 1, 4, 6, 9, e 11.

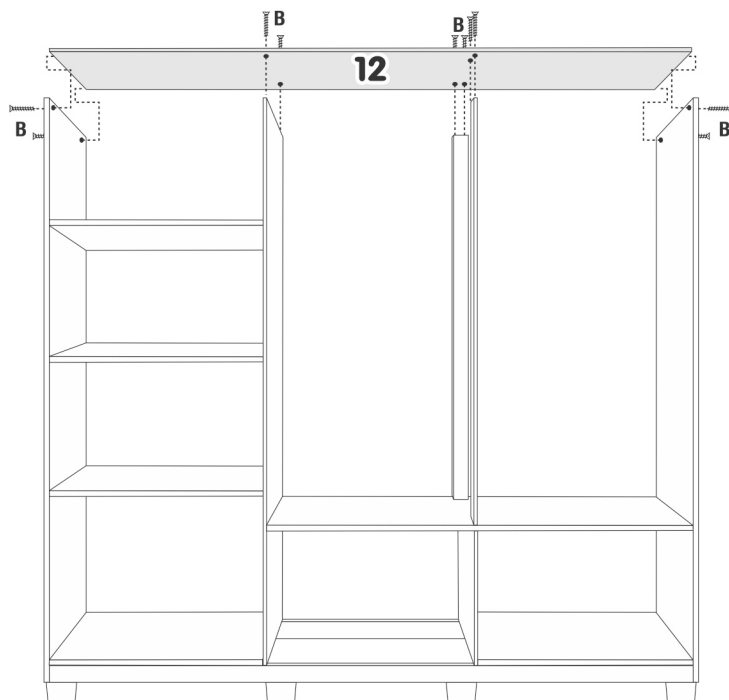
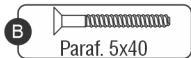

Sequência de Montagem

- 12 - Parafusar a peça 13 nas peças 1, 4, e 12;
- 13 - Parafusar as correijas nas peças 6 e 7;
- 14 - Parafusar suporte de cabideiro conforme desenho ao lado.



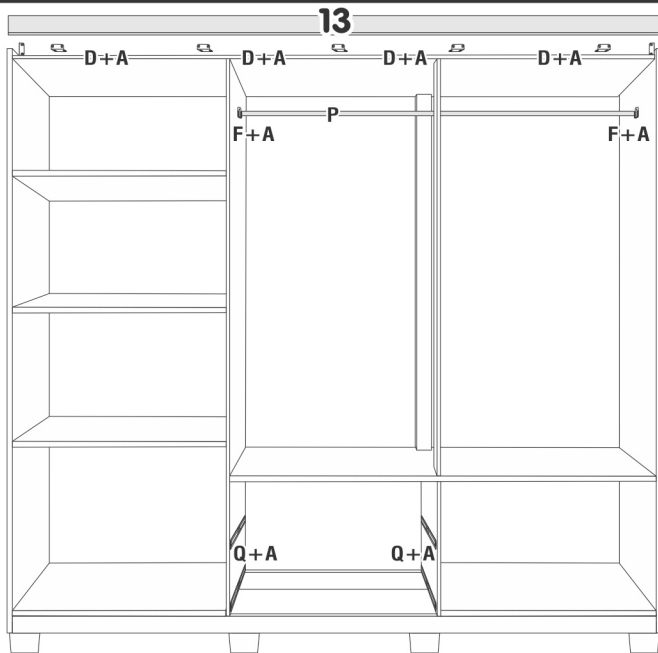

- A**  Paraf. 3,5x14
- D**  Cant. 4 Furos
- F**  Suporte Cabideiro
- Q**  Cor. Telescópica

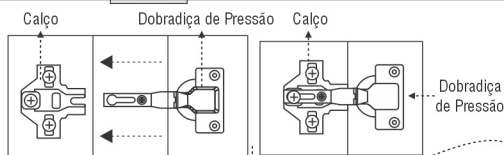
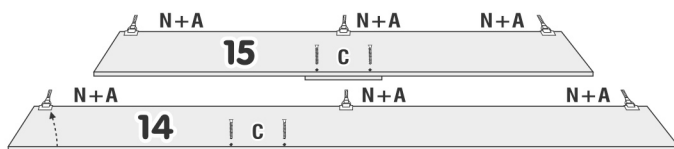
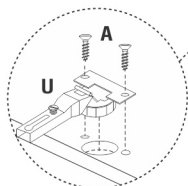

Sequência de Montagem

- 15 - Montar e fixar as Portas 14 e 15.



- A**  Paraf. 3,5x14
- C**  Paraf. 4x25
- M**  Puxador
- N**  Dobradilha Pressão
- O**  Calço

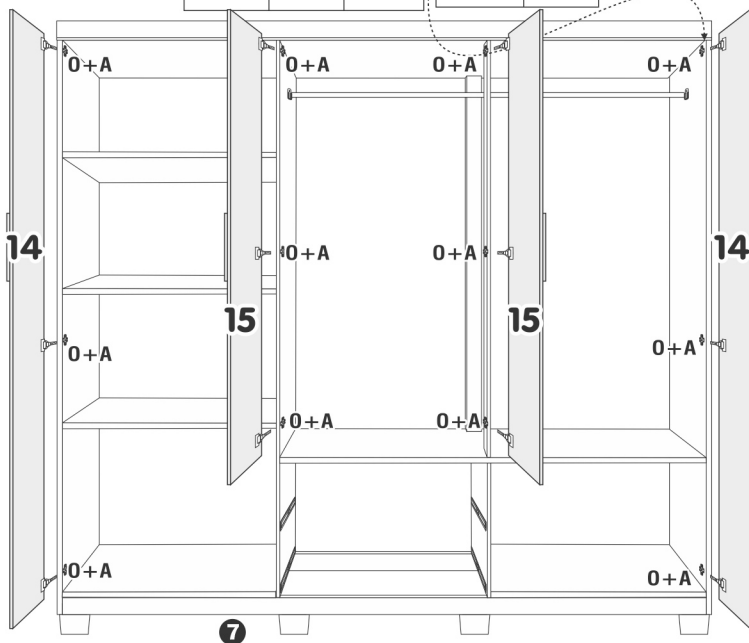

Sequência de Montagem

16 - Preguar as Costas 20 conforme desenho ao alado.

OBS.: Acertar as costas para melhor esquadramento do móvel.

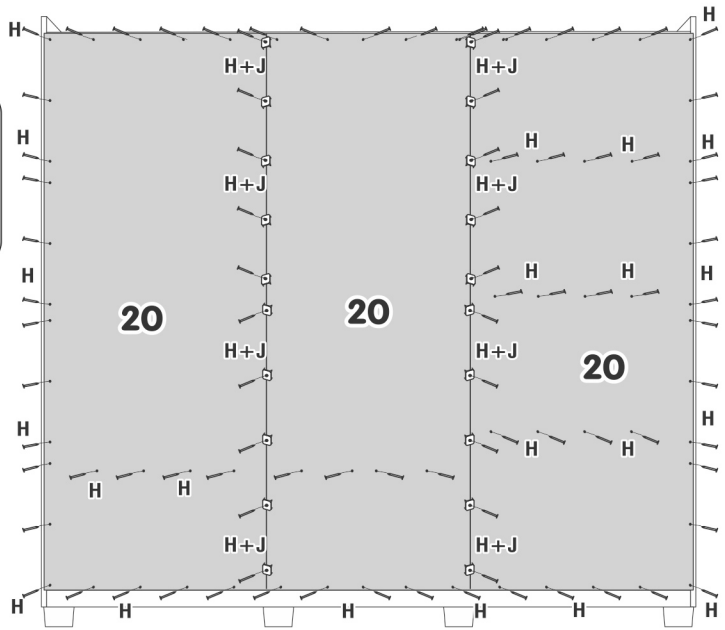

Sequência de Montagem

- 17 - Parafusar as cantoneiras nas peças 17;
- 18 - Parafusar as peças 17 nas peças 16;
- 19 - Parafusar a peça 18 nas peças 17;
- 20 - Parafusar peça 19 nas peças 17 e 18 conforme desenho abaixo, ajustando para melhor esquadramento da Gaveta;
- 21 - Parafusar as correções nas laterais da peça 17.

