

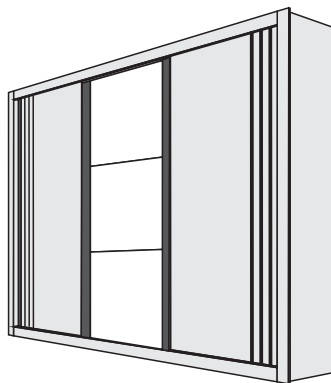

Av. das Indústrias, nº 157 - Bairro Belo Horizonte - Rodeiro /MG
 Fone/Fax (32) 3577 - 3950
 www.leifermoveis.com.br - assistencia@leifermoveis.com.br

ROUPEIRO
NEW MILANO 3PTS
 código - 22216



ACESSE O VÍDEO
 DESTE PRODUTO













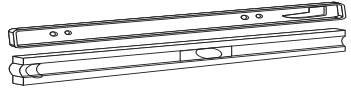

INSCREVA-SE NO CANAL

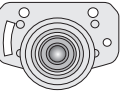
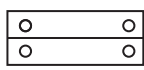
Abra a câmera do seu
 celular e
 escaneie o qr code.



ESQUEMA DE MONTAGEM

22/02/2024

 Parafuso 4,0 x 40 cabeça chata 46 UN	 Parafuso 3,5 x 12 cabeça chata 171 UN	 Par de Corrediça 04 PAR		
 Parafuso 3,5 x 35 cabeça chata 54 UN usar nos distanciadores	 Parafuso 3,5x14 cabeça chata (puxadores) 30 UN	 Fixar Costa Prego 10 x 10 70 UN		
 Cavilha 6 x 30 24 UN	 Roldanas Inferiores 06 UN	 Cantoneira Metálica 10 UN		
 GIZ 01 UN	 Suporte Cabide 06 UN	 Sapata Plástica 08 UN	 Etiqueta Leifer 01 UN	 Cola Sachê 01 UN
	 Batente de Silicone 08 UN	 Cantoneira Plástica 14 UN		

Nº	DESCRIÇÃO	QT.	CINAMOMO	FREIJÓ	BRANCO
01	RODAPÉ FRONTAL	01	22271	22271	22271
02	RODAPÉ TRASEIRO	01	22272	22272	22272
03	RODAPÉ CENTRAL	02	22274	22274	22274
04	BASE	01	22270	22270	22270
05	LATERAL ESQUERDA	01	22276	22276	22276
06	DIVISÓRIA ESQUERDA	01	22277	22277	22277
07	DIVISÓRIA DIREITA	01	22278	22278	22278
08	LATERAL DIREITA	01	22275	22275	22275
09	PRATELEIRA DO GAVETEIRO	03	22279	22279	22279
10	PRATELEIRA CENTRAL/MALEIRO	05	22280	22280	22280
11	TAMPO SUPERIOR	01	22281	22281	22281
12	MOLDURA SUPERIOR	01	22298	22298	22298
13	MOLDURA LATERAL	02	22296	22296	22296
14	DISTANCIADOR FRONTAL	04	16336	16336	16336
15	DISTANCIADOR TRASEIRO	04	16337	16337	16337
16	TRILHO INFERIOR	01	-----	-----	-----
17	TRILHO SUPERIOR	01	-----	-----	-----
18	FRENTE DE GAVETA	04	22300	22300	22300
19	LATERAL DE GAVETA	08	13200	13200	13200
20	FUNDO DE GAVETA	04	20035	20035	20035
21	TRASEIRO DE GAVETA	04	20036	20036	20036
22	COSTAS	05	22332	22332	22332
23	PORTAS LATERAIS	02	22316	22316	22316
24	PORTA CENTRAL	01	22312	22312	22312
25	PUXADOR	04	22322	22322	22322
26	ENCABECAMENTO	02	22330	22330	22330
27	CABIDEIRO	03	-----	-----	-----
28	KIT FERRAGEM	01	22334	22334	22334

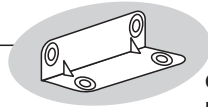
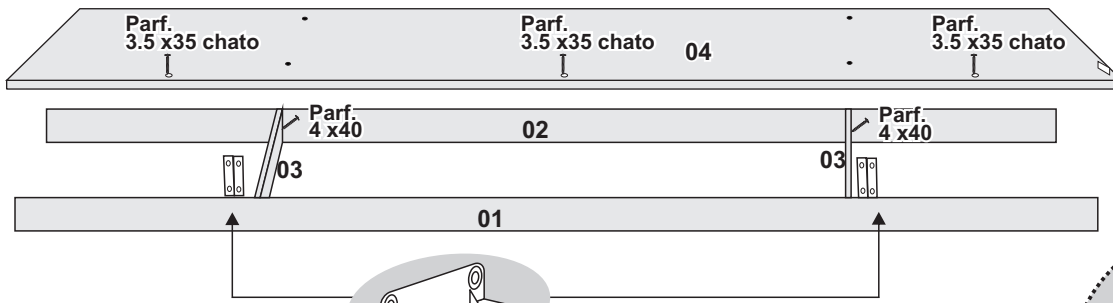

Cantoneira 04 furos +
paraf. 3,5 x 12

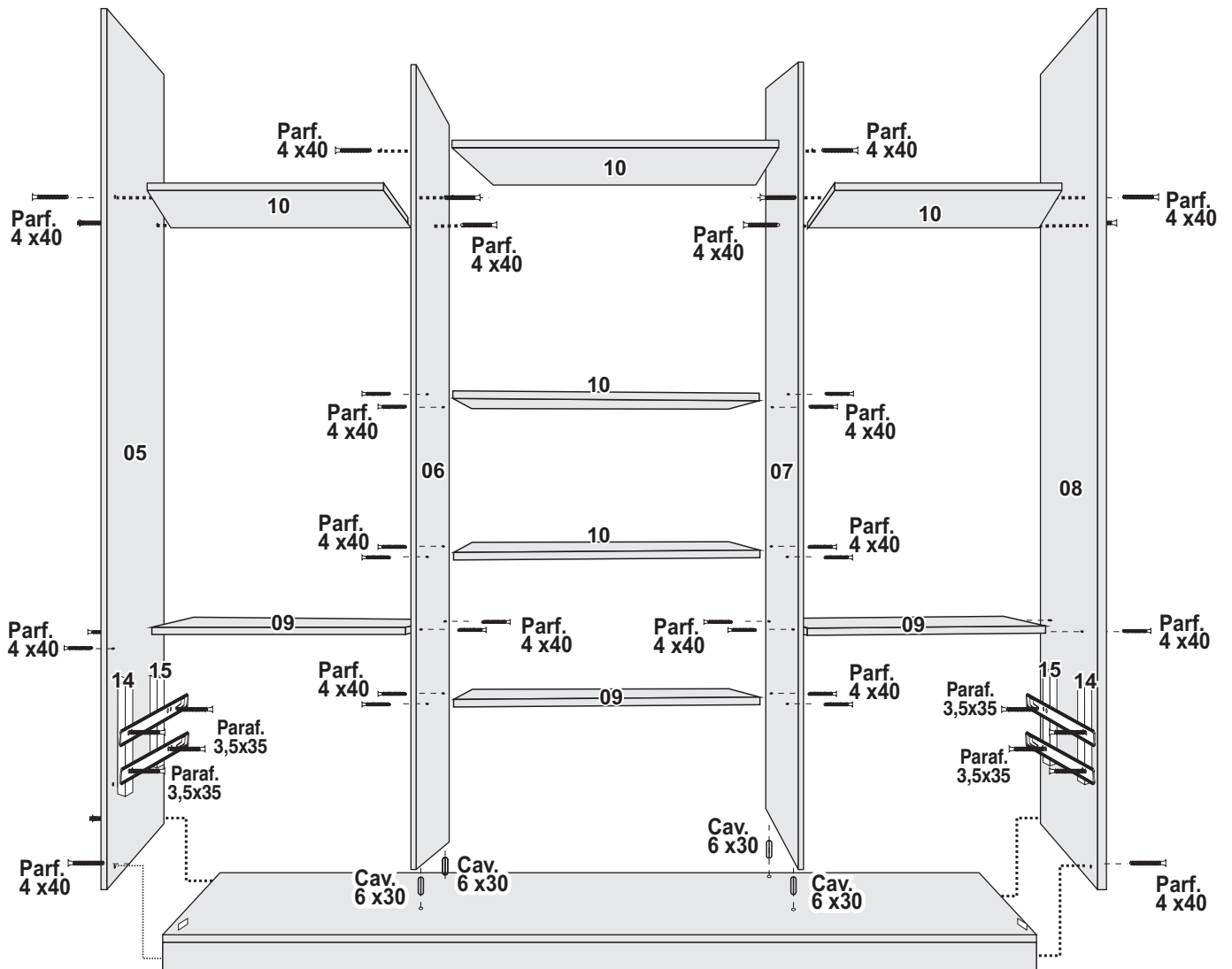
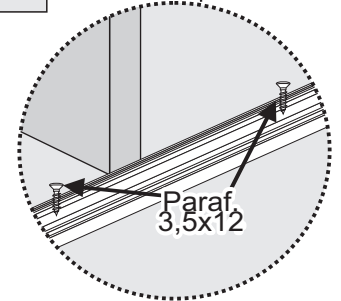

Atenção Sr. Montador

Montagem da Moldura Superior

Para montagem da moldura superior usar CANTONEIRA PLÁSTICA 04 FUROS E PARAFUSO 3,5X12. Após parafusar as 04 Cantoneiras na Moldura superior, levar a moldura até o tampo superior nº 11 e parafusar de baixo para cima usando parafuso 3,5x12.

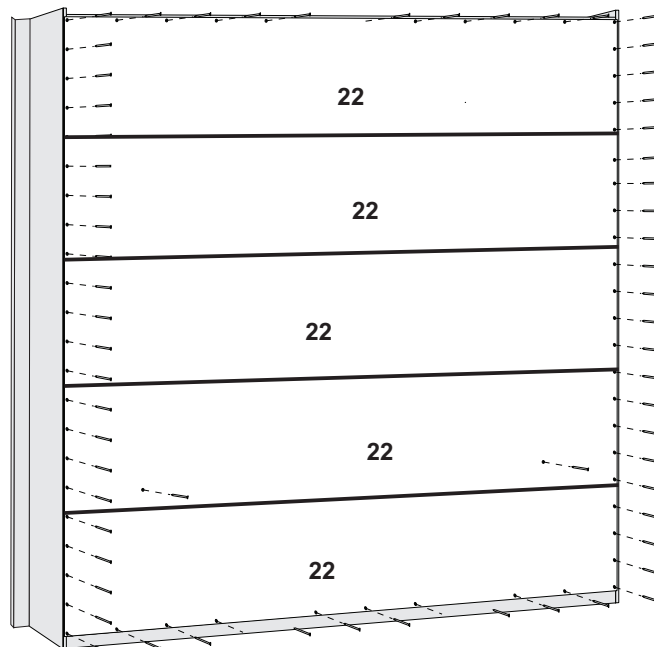
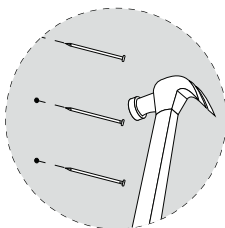
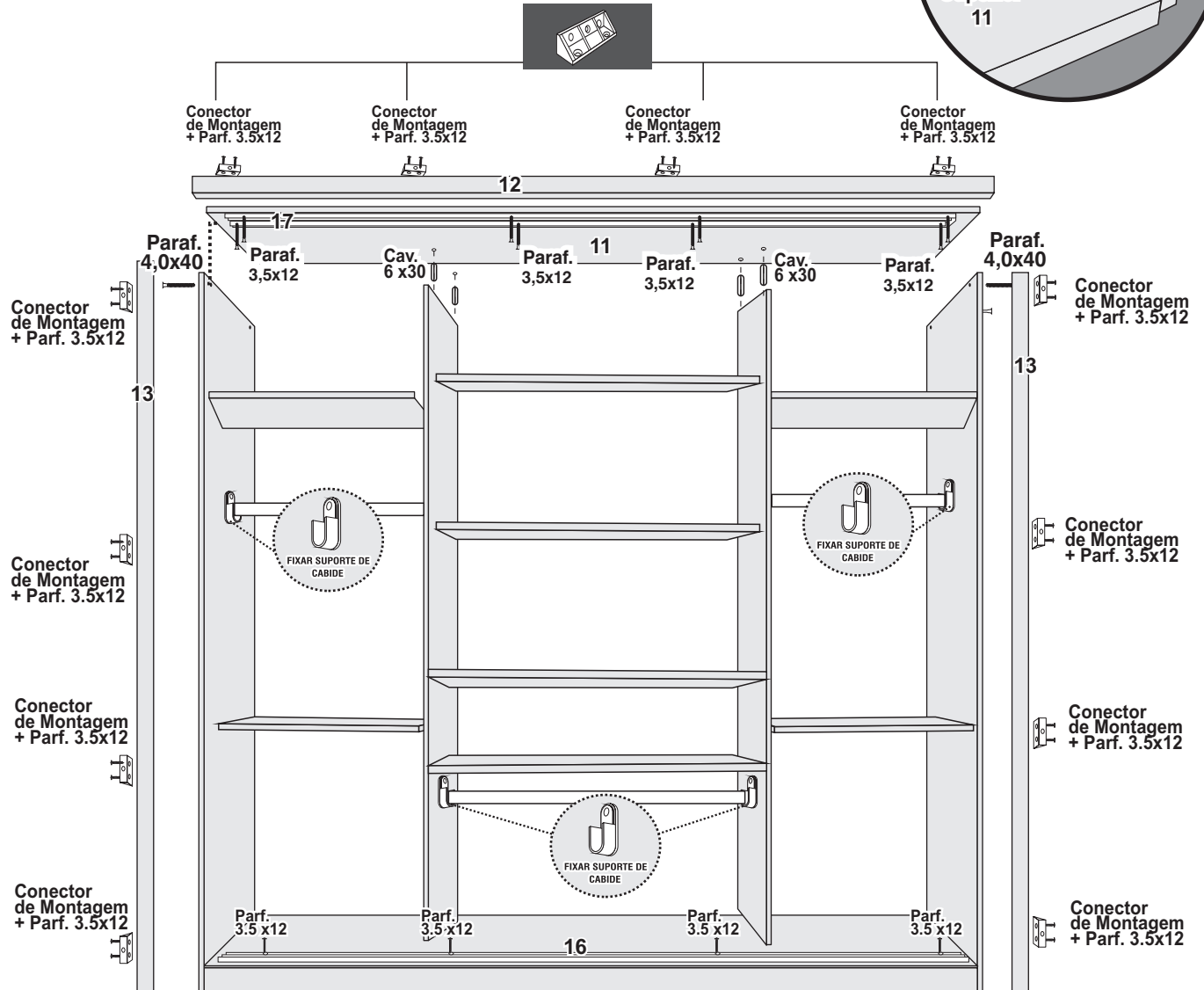
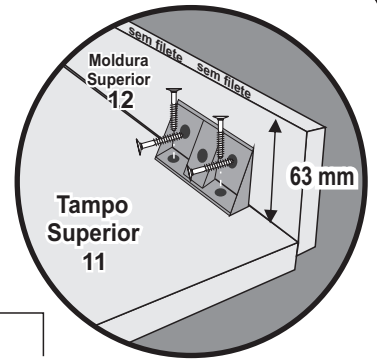

Porta Central c/ espelho e Puxadores

Para fixar o espelho favor usar fita adesiva dupla face.

Usar 12 fitas por espelho, totalizando 36 fitas.

Para fixação dos puxadores na porta central usar parafuso 3,5 x 14.abeçamento

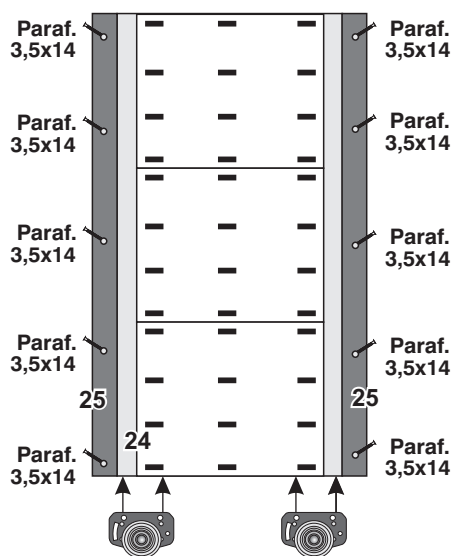

Fixar as roldanas com paraf.3,5x12

Porta Lateral c/ espelho e Puxadores

Para fixar o espelho favor usar fita adesiva dupla face.

Usar 08 fitas por espelho, totalizando 36 fitas.

Para fixação dos puxadores na porta central usar parafuso 3,5 x 14.abeçamento

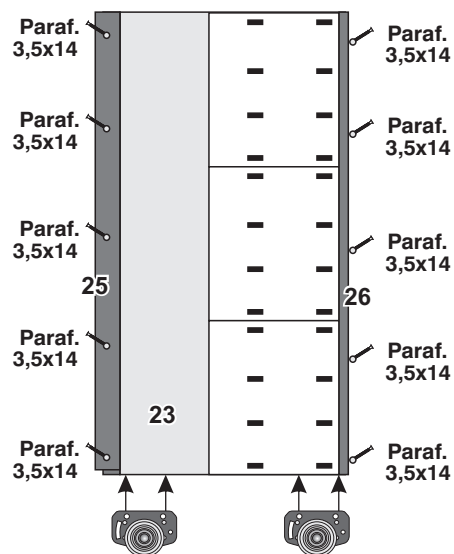

Fixar as roldanas com paraf.3,5x12

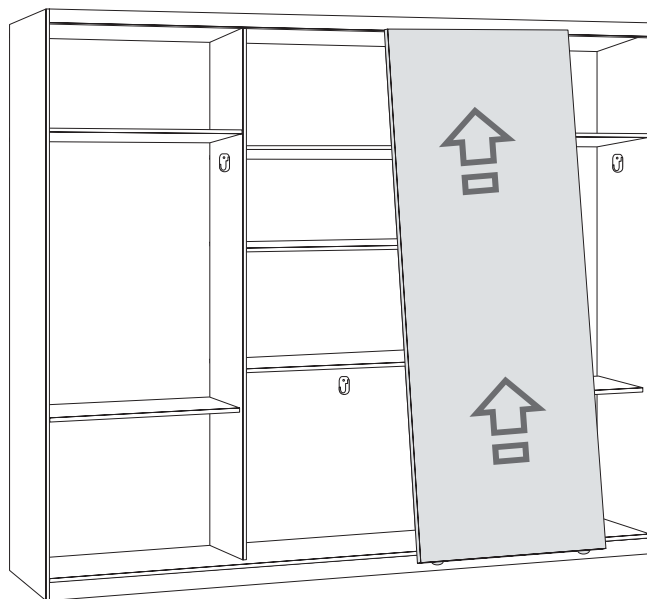

PRIMEIRO ENCAIXE A PORTA NO GUIA SUPERIOR E EM SEGUIDA ENCAIXE NO TRILHO INFERIOR, ALINHE A PORTA E PRAFUSE O TRILHO.

ENCAIXE DAS PORTAS NO TRILHO SUPERIOR.

MONTAGEM DAS GAVETAS

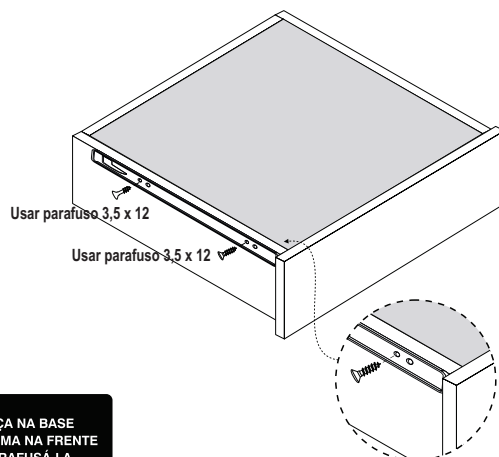
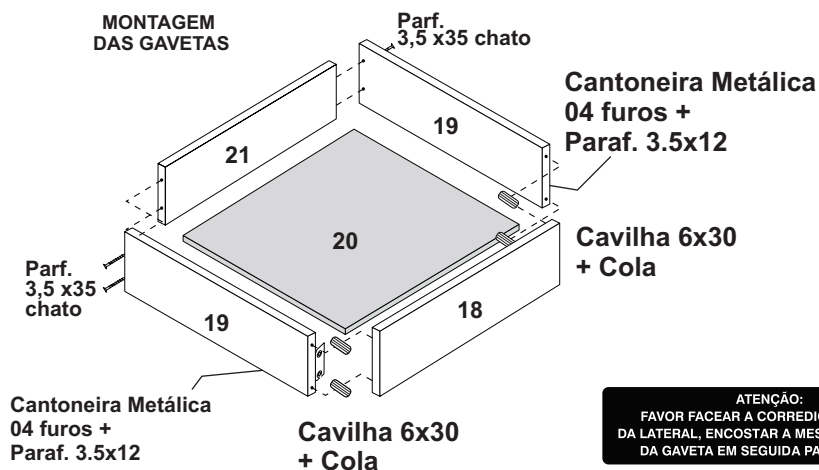

ATENÇÃO:
FAVOR FACEAR A CORREDIÇA NA BASE DA LATERAL, ENCOSTAR A MESMA NA FRENTE DA GAVETA EM SEGUIDA PARAFUSÁ-LA.