



SALAS E DORMITÓRIOS

Av. das Indústrias, nº 157 - Bairro Belo Horizonte - Rodeiro /MG
Fone/Fax (32) 3577 - 3950
www.leifermoveis.com.br - assistencia@leifermoveis.com.br

CÔMODA DIAMANTE

CÔMODA DIAMANTE - CÓD: 14717

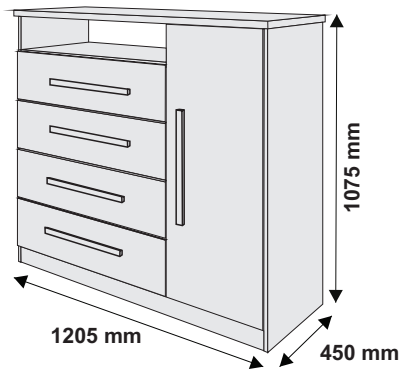

ACESSE O VÍDEO
DESTE PRODUTO











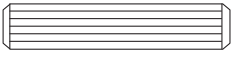

INSCREVA-SE NO CANAL

Abra a câmera do seu
celular e
escaneie o qr code.

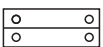

ESQUEMA DE MONTAGEM

29/03/2023

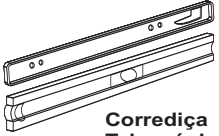
 Parafuso 5,0 x 50 chata 20 UN	 Parafuso 3,5 x 30 c/ chata 04 UN	 Cavilha 6 x 30 26 UN
 Parafuso 4,0 x 40 cabeça chata 18 UN	 Parafuso 3,5 x 14 116 UN	
 Prego 10 x 10 (fixar nas costas) 40 UN	 Parafuso 3,5 x 25 Flangeado 10 UN	 Tampa cabeça de Parafuso c/ Pino 10 mm 14 UN
 Cantoneira Métálica 14 UN	 08 UN Sapata	 01 UN COLA
	 08 UN Fixador Fundo de Gaveta Suporte Triangular	 04 UN Corrediça Telescópica

Nº	DESCRIÇÃO	QT.	CÓD. FREIJÓ	CÓD. BRANCO	CÓD. BRAÚNA
01	RODAPÉ FRONTAL	01	00465	00465	00465
02	RODAPÉ TRASEIRO	01	00466	00466	00466
03	BASE	01	21279	21279	21279
04	LATERAL DIREITA	01	21280	21280	21280
05	DIVISÃO CENTRAL	01	00472	00472	00472
06	LATERAL ESQUERDA	01	21281	21281	21281
07	PRATELEIRA SAPATEIRA	02	00477	00477	00477
08	PRATELEIRA CÔMODA	01	00473	00473	00473
09	TAMPO SUPERIOR	01	21282	21282	21282
10	PORTA CÔMODA	01	00479	00479	00479
11	FRENTE DE GAVETA	02	00482	00482	00482
12	FRENTE DE GAVETA CENTRAL	02	00496	00496	00496
13	LATERAL DIREITA DE GAVETA	04	00485	00485	00485
14	LATERAL ESQUERDA DE GAVETA	04	00487	00487	00487
15	FUNDO DE GAVETA	04	00490	00490	00490
16	TRASEIRO DE GAVETA	04	00489	00489	00489
17	COSTA	02	00491	00491	00491
18	COSTA SAPATEIRA	01	00492	00492	00492
19	KIT FERRAGEM	01	21277	21277	21277



Acesse também nossos canais on-line
f /Leifer Móveis

*Conheça também o
nosso portal na web

Entre e tenha acesso ao nosso catálogo
virtual com todos nossos produtos,
lançamentos e conteúdos exclusivos.

www.leifermoveis.com.br



Acesse também nossos canais on-line
f /Leifer Móveis

01- COMECE A MONTAGEM PELOS RODAPÉS E BASE :

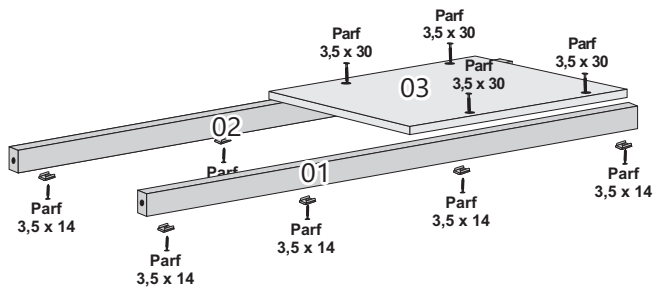

03- PARAFUSAR A PRATELEIRA Nº08 CONFORME IMAGEM ABAIXO COM ARAFUSO 5,0X50

PARAFUSE AS CORREDIÇAS TELESCÓPICAS NAS MARCAÇÕES DA LATERAL E DIVISÓRIA :

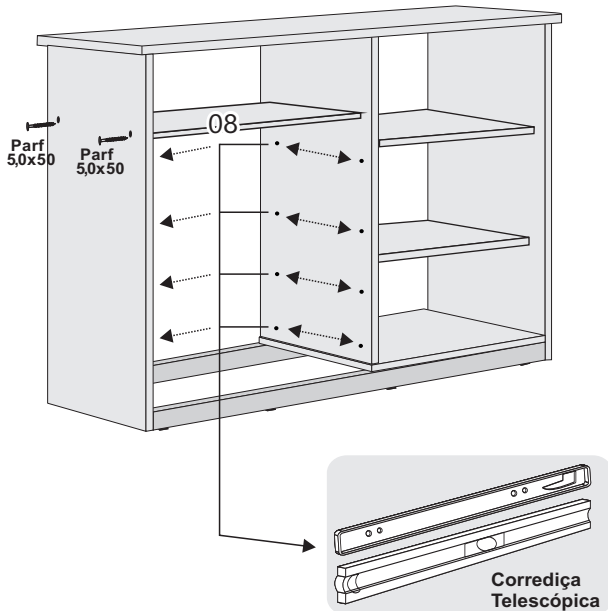

02- MONTAGEM DAS LATERAIS, DIVISÃO, PRATELEIRAS E TAMPO SUPERIOR:

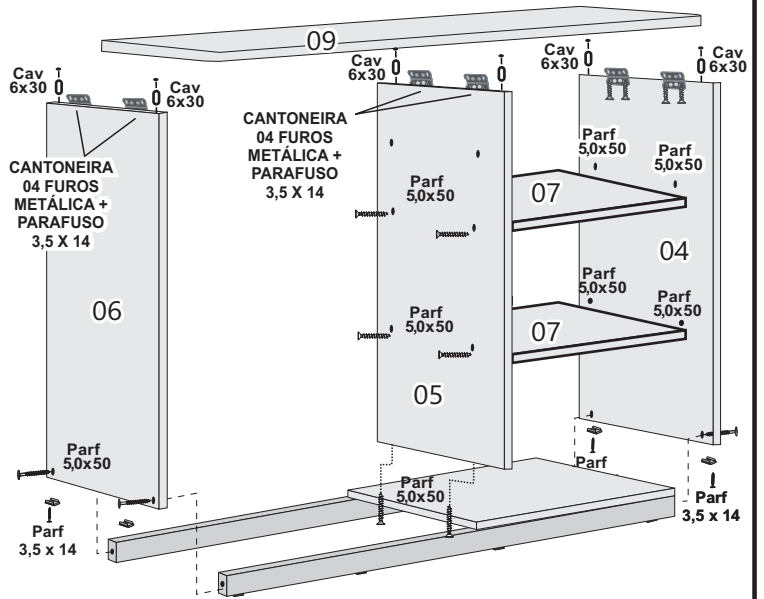

04- FIXAÇÃO DAS DOBRADIÇAS E PUXADOR NA PORTA:

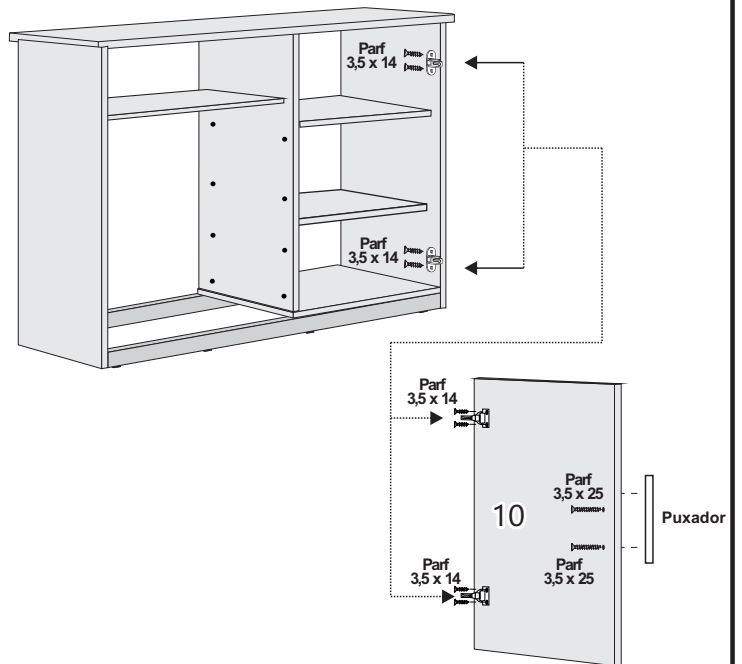

05- MONTAGEM DAS GAVETAS

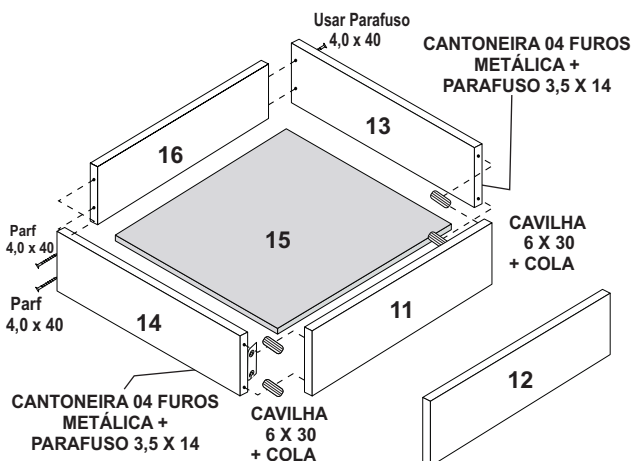

06- DETALHE FIXAÇÃO COSTAS COM PREGO 10X10

